

Amphenol Australia



ENTERTAINMENT @ AMPHENOL
TRUSTED GLOBALLY

ENTERTAINMENT INTERCONNECT CATALOGUE



Amphenol Australia Pty. Ltd.

Amphenol Australia's head office is based in Melbourne, Victoria and is the Sales, Marketing and Engineering centre of excellence for an extensive range of professional connector and cabling products.

Amphenol's global presence allows us to take full advantage of our numerous corporate resources and product portfolio to provide you with a vast offering and choice. Our extensive range is designed to meet the specific needs of the entertainment markets to make the selection of your interconnect partner an easy choice.

The company has been producing products for the pro-audio industry for over fifty years. Since the development of our XLR AC Series connectors, we have continued to provide our customers with exacting quality in an increasingly competitive environment.

Continuous improvement through ISO9001, a focus on environmental awareness and development of next generation industry leading products is our philosophy. As the entertainment industry moves into the future the emerging technologies from other industries has become more prevalent and more challenging. Amphenol Australia's global presence combined with its close technical relationships with other Amphenol sister divisions, each a specialist and leader in their own interconnect field, places it well to support innovation and meet this challenge head on.

The ability of Amphenol to provide a full range of design services required to support the customers applications design and modelling, applications engineering, fabrication, value-added assembly and testing, coupled with the largest interconnect offering on the market means that we can support all of your system level needs.

CONTENTS

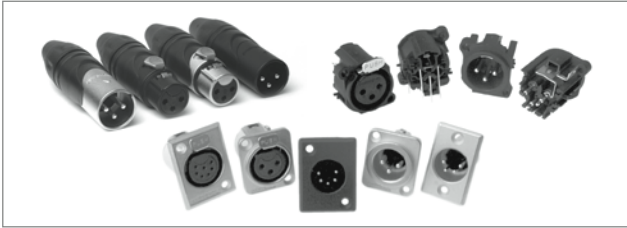

XLR Connectors

AX Series XLR Cable Connectors	2
AC Series XLR Cable Connectors	9
AC/AX Series XLR Metal Chassis Mount Connectors	16
AC Series XLR PCB Chassis Mount Connectors.....	28
AC Series Dual 1/4" (6.35mm) / XLR Chassis Mount	42
G-Type Miniature XLR Connectors	51



Data Connectors

Amphe-Dante Adapters.....	75
XLRnet Series Cable Connector	79
XLRnet Series A & B Type Chassis Receptacles.....	82
XLRnet Series D Type Chassis Receptacles	85
USB/HDMI Series	90



Power Connectors

HP Series.....	70
HPT Series	72



Multipin Connectors

MP-41 Series	126
MP-62/65 Series	131



Plugs & Jacks

T Series Plugs	94
T Series (Jumbo) Plugs	96
T-Series SwitchPlug	98
Q-Series Plugs.....	100
Musician Series II Plugs	103
1/4" / 3.5mm Phone Jack Connectors	108
K Series Plugs (3.5mm).....	118



Speaker Connectors

SP Series.....	56
EP Series	65
AP Series.....	67



Plugs & Sockets

RCA Series	122
------------------	-----



Miscellaneous

Accessories	134
Connector Wiring Information	138
Index	140
Product Safety Information	143

XLR Connectors

AX Series XLR Cable Connectors



AX SERIES XLR CABLE CONNECTORS

The revolutionary AX series of XLR connectors introduce an exciting contemporary look and feel to the professional audio interconnect market. They are designed to complement modern audio architecture and truly "fit" within their environment. An impressive list of features guarantees pure sound performance in the most demanding applications providing unrivalled value.

Features

- Unique Australian designed shell and housing.
- One piece ground / latch spring design incorporating twin wipe contacts for a direct connection path from mating shell to ground providing enhanced connection and EMI performance.
- Ergonomic sleeve design for improved grip.
- Channel I.D capability with coloured sleeves.
- Oversized ergonomic latch for quick and easy mating.
- Leading first mate last break pin 1 on socket connectors.
- Chuck style cable clamp to suit 3mm - 8mm (0.118" - 0.314") cable O.D. with integrated split to allow inclusion after soldering.
- Concealed latching point for improved aesthetics, sealing and strength.
- Overmolded boot with flex bend relief for improved aesthetics, cable protection and boot retention.
- Concentric socket contact design provides optimal contact resistance
- Precision machined pin contacts as standard.
- Compact solder buckets to reduce termination time and material wastage during the soldering process.
- Zinc diecast shell housing for robustness and wear with Satin nickel or Black finish.
- Available in 3,4 and 5 contact arrangements.

Options

- Coloured I.D sleeves.
- Satin nickel or Black shell finish.
- Single or Bulk packaging.
- Gold plated contacts.

Ordering Codes

We have listed the more common ordering codes in each section. For further options please refer to the part number breakdown charts. Please contact us if you need any further assistance.

Simple steps to guide you in using this catalogue

- 1) Identify the product group listed in Contents on page 1 and go directly to that page number.
- 2) Each product group cover page then details information and options available.
- 3) Refer to the product detail pages and identify the product you require pictorially.
- 4) Read the product description column for the products standard features.
- 5) Use variations column to determine your choice.
- 6) Identify part number.
- 7) In the event the particular option you require is not listed please refer to the part number breakdown page at the end of each section.
- 8) Please contact us directly if you have any further problems.

XLR Connectors

AX Series XLR Cable Connectors



Features:

- Unique Australian designed shell and housing.
- Ergonomic stylish sleeve design for improved grip.
- Oversized latch lever preserves your thumb.
- Leading first mate last break pin 1 on socket connectors.
- Chuck style cable clamp to suit 3mm - 8mm (0.118" - 0.314") cable O.D. with integrated split to allow inclusion after soldering.
- Overmolded cable support boot.
- New socket contact design for improved contact resistance.
- Precision machined pin contacts as standard.
- Compact solder buckets to reduce soldering time and wastage.
- Zinc diecast shell housing with Satin nickel or Matt black finish.
- Available in 3,4 and 5 contact arrangements.

Options:

- Coloured I.D sleeves.
- Satin nickel or Matt black shell finish.
- Single or Bulk packaging.

Part Number Breakdown: Page 5

Specifications: Page 8











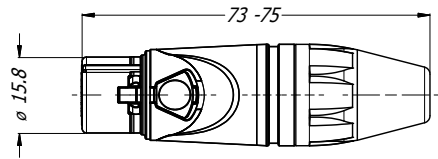

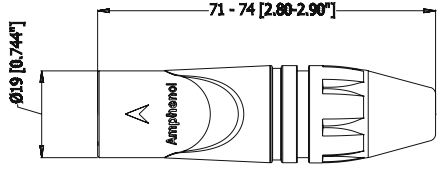

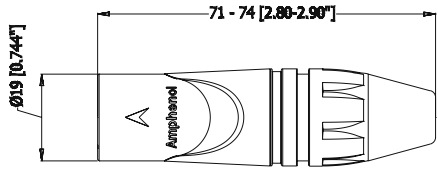

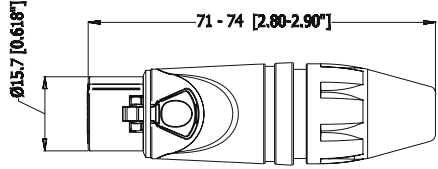
Assembly Instructions: Page 6 & 7

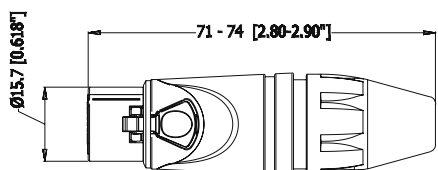
PRODUCT - FIGURE	DRAWING	Dimensions in mm (inches)	DESCRIPTION	VARIATIONS	PART NUMBER
			XLR 3 pole male Machined contacts Nickel Finish	Standard	AX3M
				Bulk Pack	AX3M BULK
			XLR 3 pole male Machined contacts Black Finish	Standard	AX3MB
				Gold Plated Contacts	AX3MB-AU
				Bulk Pack	AX3MB BULK
			XLR 3 pole female Stamped contacts Nickel Finish	Standard	AX3F
				Bulk Pack	AX3F BULK
			XLR 3 pole female Stamped contacts Nickel Finish	Standard	AXX3F
			XLR 3 pole female Stamped contacts Black Finish	Standard	AX3FB
				Gold Plated Contacts	AX3FB-AU
				Bulk Pack	AX3FB BULK

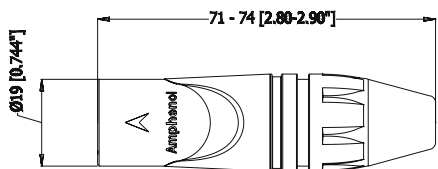
*PI538 is available for download at www.amphenolaudio.com

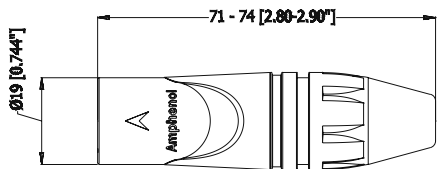
XLR Connectors

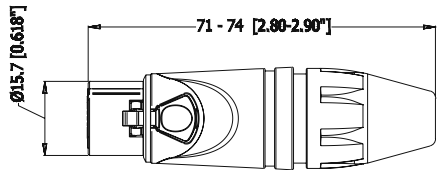
AX Series XLR Cable Connectors

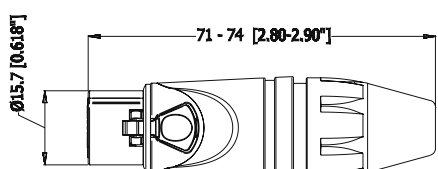
PRODUCT - FIGURE	DRAWING	Dimensions in mm (inches)	DESCRIPTION	VARIATIONS	PART NUMBER
		73 - 75 ø 15.8	XLR 3 pole female Stamped contacts Nickel Finish	Standard	AXX3FB
		71 - 74 [2.80-2.90"] ø19 [0.744"]	XLR 4 pole male Machined contacts Nickel Finish	Standard	AX4M
		71 - 74 [2.80-2.90"] ø19 [0.744"]	XLR 4 pole male Machined contacts Black Finish	Standard	AX4MB
				Gold Plated Contacts	AX4MB-AU
				Bulk Pack	AX4MB BULK
		71 - 74 [2.80-2.90"] ø15.7 [0.618"]	XLR 4 pole female Machined contacts Nickel Finish	Standard	AX4F
				Bulk Pack	AX4F BULK
		71 - 74 [2.80-2.90"] ø15.7 [0.618"]	XLR 4 pole female Machined contacts Black Finish	Standard	AX4FB
				Gold Plated Contacts	AX4FB-AU
				Bulk Pack	AX4FB BULK
		71 - 74 [2.80-2.90"] ø19 [0.744"]	XLR 5 pole male Machined contacts Nickel Finish	Standard	AX5M
				Bulk Pack	AX5M BULK
		71 - 74 [2.80-2.90"] ø19 [0.744"]	XLR 5 pole male Machined contacts Black Finish	Standard	AX5MB
				Gold Plated Contacts	AX5MB-AU
				Bulk Pack	AX5MB BULK
		71 - 74 [2.80-2.90"] ø15.7 [0.618"]	XLR 5 pole female Machined contacts Nickel Finish	Standard	AX5F
				Bulk Pack	AX5F BULK
		71 - 74 [2.80-2.90"] ø15.7 [0.618"]	XLR 5 pole female Machined contacts Black Finish	Standard	AX5FB
				Gold Plated Contacts	AX5FB-AU
				Bulk Pack	AX5FB BULK

PART NUMBER BREAKDOWN

METAL SHELL TYPE - SOLDER

E. G . **AX3MB2M-AU BULK**
AX (Series Prefix), **3** contacts, **Male**, **Black** Finish,
2 (Red Sleeve) **M** (Sleeve Marking) - **AU** (Gold Plated Contacts), **Bulk** Packaged.

SERIES PREFIX	AX = Series Prefix
CONTACT LAYOUTS	3 = 3 Contacts 4 = 4 Contacts 5 = 5 Contacts
GENDER	F = Female Socket Contacts M = Male Pin Contacts
SHELL FINISH	Blank = Nickel Plated Finish B = Black Finish
SLEEVE COLOUR OPTION	Blank = Black 1 = Brown 2 = Red 3 = Orange 4 = Yellow 5 = Green 6 = Blue 7 = Violet 8 = Grey 9 = White
SLEEVE MARKING	Blank = Standard Sleeve OM = Marking Sleeve (Black) M = Marking Sleeve (Colour)
CONTACT PLATING	Blank = Standard Plating (Silver or Tin) (Refer to Standard Data) AU = Gold Plated
PACKAGING	Blank = Individual Bags BULK = Bulk Packed

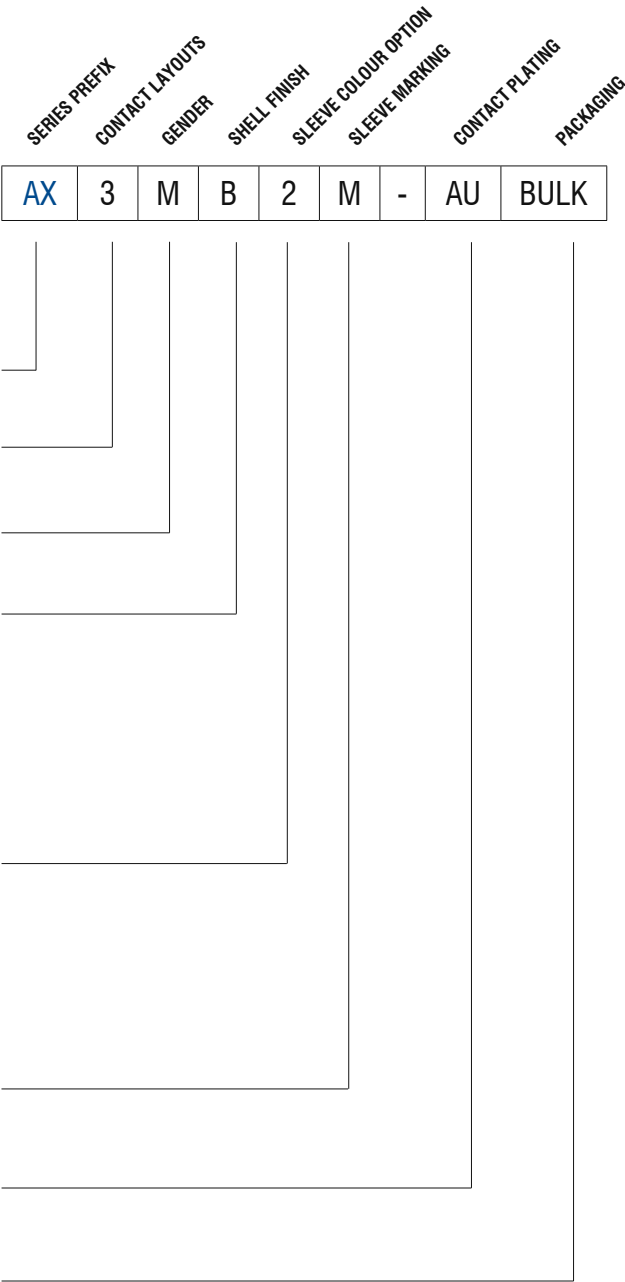

XLR Connectors

AX Series XLR Cable Connectors

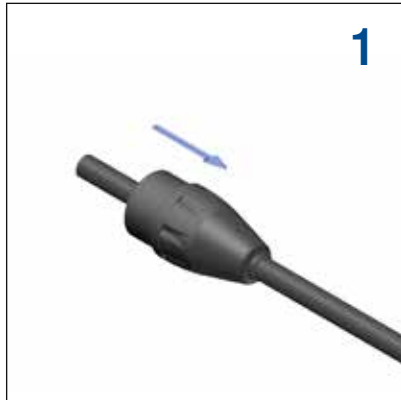

Slide the nut (Backshell) onto the cable

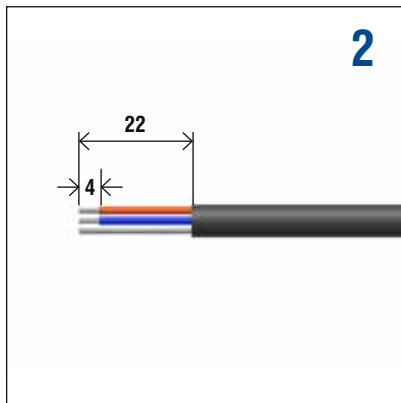

Strip the cable



Push back the insert only enough to expose the solder buckets. It is not necessary to remove the insert. Solder the wires to the contacts.



Install the cable clamp, flush to the insert making sure to align the top slot with the spring. Then push the insert & cable clamp together into the shell.



Thread the nut (Backshell) onto the shell (Torque 0.8Nm - 1.2Nm) to activate the cable clamp and close the connector assembly.

PI539 ASSEMBLY INSTRUCTIONS

AX SERIES FEMALE XLR CABLE CONNECTOR

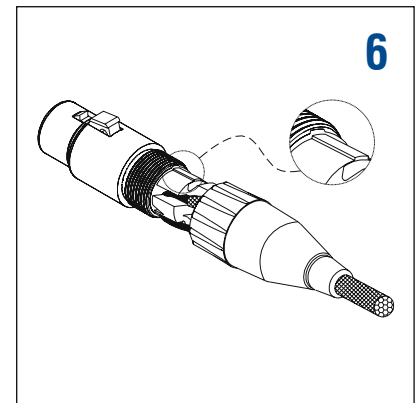

Close the cable clamp slightly and push the boot over the clamp ensuring the wires fit inside the boot.

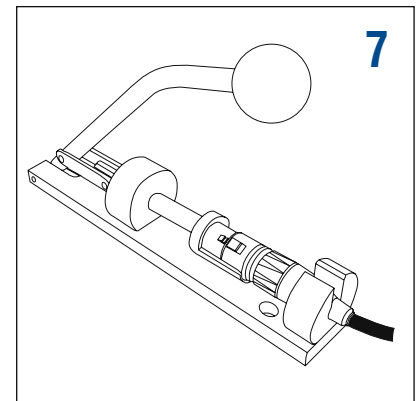

Final assembly can be achieved either by manually screwing the boot on, or by using an Amphenol Australia T2860 termination tool.

PI538 ASSEMBLY INSTRUCTIONS

AX SERIES MALE XLR
CABLE CONNECTOR

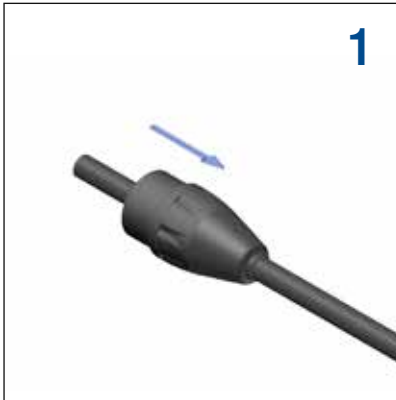

Slide the nut (Backshell) onto the cable

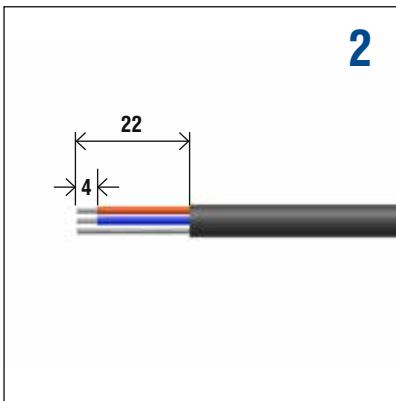

Strip the cable

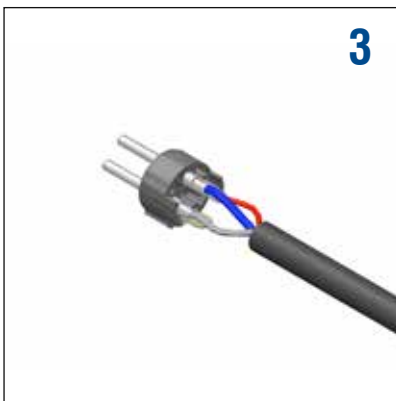

Solder the wires to the contacts.



Install the cable clamp flush to the insert making sure to align the slot with the ground contact.



Align the key of the insert with the keyway on the shell then push the pin insert & cable clamp together in the shell.





Thread the nut (Backshell) onto the shell (Torque 0.8Nm - 1.2Nm) to activate the cable clamp and close the connector assembly.

XLR Connectors

AX Series XLR Cable Connectors

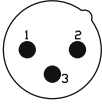
STANDARD DATA AX SERIES CABLE CONNECTORS

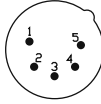
		VALUE		
GENERAL CHARACTERISTICS	Number of contacts	3	4	5
	AX Series Contact Arrangements (Front view of pin inserts)			
	Termination	SOLDER		
	Max. Wire Gauge - Stranded wire: Solder	14AWG	16AWG	18AWG
	Flammability rating of insulator plastics and housings	UL94V-0		
	Environmental	Complies with EU RoHS 2 Directive 2011/65/EU		
ELECTRICAL CHARACTERISTICS	Service Voltage RMS	133V ¹⁾		
	Test Voltage AC RMS	1400V		
	Current carrying capacity: Solder	15A	10A	7.5A
	Typical Contact Resistance	≤3m Ω		
	Insulation Resistance	≥1G Ω		
CLIMATIC CHARACTERISTICS	Protection Class	IP40		
	Operating Temperature	-25°C to +75°C (-13°F to +167°F)		
MECHANICAL CHARACTERISTICS	Insertion and Withdrawal force	≥10N - ≤30N		
	Weight ²⁾	31g (0.068lb)	33g (0.073lb)	33g (0.073lb)
	Typical Cable retention force	22Kg to 44Kg (50lb to 100lb) - Dependent on cable material and diameter.		
	Cable O.D. range	3mm to 8mm (0.118" to 0.314")		
	Mechanical Operations	1000 mating cycles		
MATERIALS	Connector shell - Metal Shell finish	Diecast Zinc Alloy Satin nickel or Black		
	Insulators	UL94V-0 PA66, 30% Glass Filled		
	Boot / Backshell Finish	UL94V-0 Noryl N190 / Santoprene Black, other colours available - see page 80		
	Cable clamp	Noryl N190		
	Sleeve	Noryl N190		
	Male Contact Machined - Solder / Plating	Brass / Silver or Gold (Optional)		
	Female Contact Stamped - Solder / Plating	Phosphor Bronze / Tin or Gold (Optional)		

Rev 3 - 03/2013

¹⁾ Not suitable for domestic applications above 50V

²⁾ Approximate weight only, does not include packaging. Please contact us for exact weight for shipping purposes.

AC SERIES XLR CABLE CONNECTORS



Amphenol Australia have been manufacturing and designing innovative XLR connectors since 1955. The AC series cable connector range complies with IEC268-12 and AES 14-1992 standards. CSA File Number 68598.

Features

- AC series XLR connectors feature the unique Australian design and patented “Jaws” cable retention system
- A leading first mate last break socket contact is standard on all female connectors (Pin 1).
- The “Jaws” cable retention system provides up to 44kg (100lb) of strain.
- The AC series connector can be quickly and easily assembled without screws – by hand or portable termination tool. (Part number T2860)
- Available in 3, 4, 5, 6A and 7 contact arrangements.
- Compatible with all major XLR brands.

Options

- Solder Bucket termination
- Thermoplastic shell
- Zinc Diecast shell - Satin Nickel Finish
- Zinc Diecast shell - Black Polyester Finish
- Gold, Silver or Tin Plated contacts
- Bulk Style Packaging
- Single Bag packs
- Precision machined contacts
- Cost effective stamped contacts on 3 pole
- Standard Jaws cable clamp, Cable O.D 3mm to 6.5mm (0.118” to 0.255”)
- Large Jaws cable clamp, Cable O.D 6.5mm to 8mm (0.255” to 0.314”)
- Metal Boots / Backshells
- Coloured Boots / Backshells
- Coloured Identification rings
- Termination / Assembly tooling

Jaws Cable Clamp Options



Standard Jaws cable clamp (Black), Cable O.D 3mm to 6.5mm (0.118” to 0.255”)



Large Jaws cable clamp (Purple), Cable O.D 6.5mm to 8mm (0.255” to 0.314”)

Ordering Codes

We have listed the more common ordering codes in each section. For further options please refer to the part number breakdown charts. Please contact us if you need any further assistance.

Simple steps to guide you in using this catalogue

- 1) Identify the product group listed in Contents on page 1 and go directly to that page number.
- 2) Each product group cover page then details information and options available.
- 3) Refer to the product detail pages and identify the product you require pictorially.
- 4) Read the product description column for the products standard features.
- 5) Use variations column to determine your choice.
- 6) Identify part number.
- 7) In the event the particular option you require is not listed please refer to the part number breakdown page at the end of each section.
- 8) Please contact us directly if you have any further problems.

XLR Connectors

AC Series XLR Cable Connectors



Features:

- Zinc Diecast Shell.
- Solder Bucket connections.
- “Jaws” Cable Retention System.
- Contact layouts in 3, 4, 5, 6A and 7.
- Precision machined or Stamped contacts.
- Leading first mate last break socket contact.
- Quick and easy assembly without screws – by hand or portable termination tool. (Part number T2860.)

Options: Stamped Contacts (3 contact only), Gold plated contacts, Large or Small Jaws Cable Clamp, Black Finish Shell, Bulk Pack, Coloured Boots / Backshells











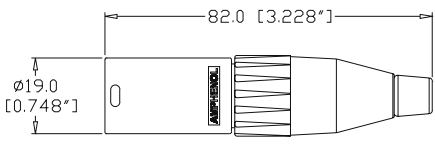

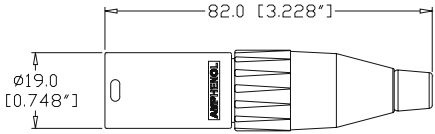

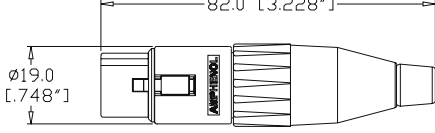
Part Number Breakdown: Page 13

Specifications: Page 15

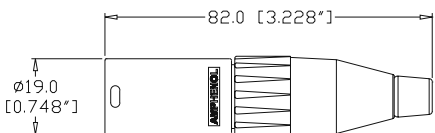
PRODUCT - FIGURE	DRAWING	DESCRIPTION	VARIATIONS	PART NUMBER
		XLR 3 pole male, Machined contacts, Nickel Finish, Jaws cable clamp	Standard	AC3MM
			Bulk Pack	AC3MM BULK
		XLR 3 pole male, Machined contacts, Black Finish, Jaws cable clamp	Standard	AC3MMB
			Gold Plated Contacts	AC3MMB-AU
			Bulk Pack	AC3MMB BULK
		XLR 3 pole male, Stamped contacts, Nickel Finish, Jaws cable clamp	Standard	AC3M
			Large Cable Clamp	AC3MJ
			Bulk Pack	AC3M BULK
		XLR 3 pole male, Stamped contacts, Black Finish, Jaws cable clamp	Standard	AC3MB
			Gold Plated Contacts	AC3MB-AU
			Large Cable Clamp	AC3MBJ
			Bulk Pack	AC3MB BULK
		XLR 3 pole female, Stamped contacts, Nickel Finish, Jaws cable clamp	Standard	AC3F
			Large Cable Clamp	AC3FJ
			Bulk Pack	AC3F BULK
		XLR 3 pole female, Stamped contacts, Black Finish, Jaws cable clamp	Standard	AC3FB
			Gold Plated Contacts	AC3FB-AU
			Large Cable Clamp	AC3FBJ
			Bulk Pack	AC3FB BULK

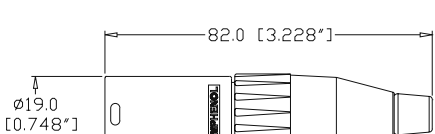
XLR Connectors

AC Series XLR Cable Connectors

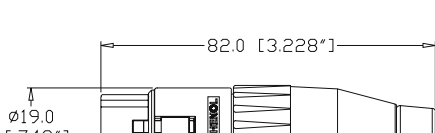
PRODUCT - FIGURE	DRAWING Dimensions in mm (inches)	DESCRIPTION	VARIATIONS	PART NUMBER
		XLR 4 pole male, Machined contacts, Nickel Finish, Jaws cable clamp	Standard	AC4M
			Large Cable Clamp	AC4MJ
			Bulk Pack	AC4M BULK
		XLR 4 pole male, Machined contacts, Black Finish, Jaws cable clamp	Standard	AC4MB
			Gold Plated Contacts	AC4MB-AU
			Large Cable Clamp	AC4MBJ
Bulk Pack	AC4MB BULK			
		XLR 4 pole female, Machined contacts, Nickel Finish, Jaws cable clamp	Standard	AC4F
			Large Cable Clamp	AC4FJ
			Bulk Pack	AC4F BULK
		XLR 4 pole female, Machined contacts, Black Finish, Jaws cable clamp	Standard	AC4FB
			Gold Plated Contacts	AC4FB-AU
			Large Cable Clamp	AC4FBJ
Bulk Pack	AC4FB BULK			
		XLR 5 pole male, Machined contacts, Nickel Finish, Jaws cable clamp	Standard	AC5M
			Large Cable Clamp	AC5MJ
			Bulk Pack	AC5M BULK
		XLR 5 pole male, Machined contacts, Black Finish, Jaws cable clamp	Standard	AC5MB
			Gold Plated Contacts	AC5MB-AU
			Large Cable Clamp	AC5MBJ
Bulk Pack	AC5MB BULK			
		XLR 5 pole female, Machined contacts, Nickel Finish, Jaws cable clamp	Standard	AC5F
			Large Cable Clamp	AC5FJ
			Bulk Pack	AC5F BULK
		XLR 5 pole female, Machined contacts, Black Finish, Jaws cable clamp	Standard	AC5FB
			Gold Plated Contacts	AC5FB-AU
			Large Cable Clamp	AC5FBJ
Bulk Pack	AC5FB BULK			

XLR Connectors

AC Series XLR Cable Connectors

PRODUCT - FIGURE	DRAWING	Dimensions in mm (inches)	DESCRIPTION	VARIATIONS	PART NUMBER
			XLR 6A pole male, Machined contacts, Nickel Finish, Jaws cable clamp	Standard	AC6AM
				Large Cable Clamp	AC6AMJ
				Bulk Pack	AC6AM BULK
			XLR 6A pole male, Machined contacts, Black Finish, Jaws cable clamp	Standard	AC6AMB
				Gold Plated Contacts	AC6AMB-AU
				Large Cable Clamp	AC6AMBJ
Bulk Pack	AC6AMB BULK				
			XLR 6A pole female, Machined contacts, Nickel Finish, Jaws cable clamp	Standard	AC6AF
				Large Cable Clamp	AC6AFJ
				Bulk Pack	AC6AF BULK
			XLR 6A pole female, Machined contacts, Black Finish, Jaws cable clamp	Standard	AC6AFB
				Gold Plated Contacts	AC6AFB-AU
				Large Cable Clamp	AC6AFBJ
Bulk Pack	AC6AFB BULK				
			XLR 7 pole male, Gold plated Machined contacts, Nickel Finish, Jaws cable clamp	Standard	AC7M
				Large Cable Clamp	AC7MJ
				Bulk Pack	AC7M BULK
			XLR 7 pole male, Gold plated Machined contacts, Black Finish, Jaws cable clamp	Standard	AC7MB
				Large Cable Clamp	AC7MBJ
				Bulk Pack	AC7MB BULK
			XLR 7 pole female, Gold plated Machined contacts, Nickel Finish, Jaws cable clamp	Standard	AC7F
				Large Cable Clamp	AC7FJ
				Bulk Pack	AC7F BULK
			XLR 7 pole female, Gold plated Machined contacts, Black Finish, Jaws cable clamp	Standard	AC7FB
				Large Cable Clamp	AC7FBJ
				Bulk Pack	AC7FB BULK

PART NUMBER BREAKDOWN

METAL SHELL TYPE - SOLDER

E. G. **AC3MMBJ-AU BULK**
AC (Series Prefix), **3** contacts, **Male**, **Machined Contacts**, **Black Polyester Finish**,
J (Large Jaws),- **AU** (Gold Plated Contacts), **Bulk** Packaged.

SERIES PREFIX	AC = Series Prefix
CONTACT LAYOUTS	3 = 3 Contacts 4 = 4 Contacts 5 = 5 Contacts 6A = 6 Contacts 7 = 7 Contacts
GENDER	F = Female Socket Contacts M = Male Pin Contacts
CONTACT¹	Blank = Stamped Contacts M = Machined Contacts G = Stamped Contacts, Ground Tag MG = Machined Contacts, Ground Tag (Applicable 3 male pin contacts, option M & MG only)
SHELL FINISH²	Blank = Nickel Plated Finish B = Black Polyester Finish
CABLE CLAMP	Blank = Standard Jaws 3mm - 6.5mm cable O.D. (0.118" to 0.255") J = Large Jaws 6.5mm - 8mm cable O.D. (0.255" to 0.314")
CONTACT PLATING³	Blank = Standard Plating (Silver or Tin) (Refer to Standard Data) AU = Gold Plated
PACKAGING	Blank = Individual Bags BULK = Bulk Packed

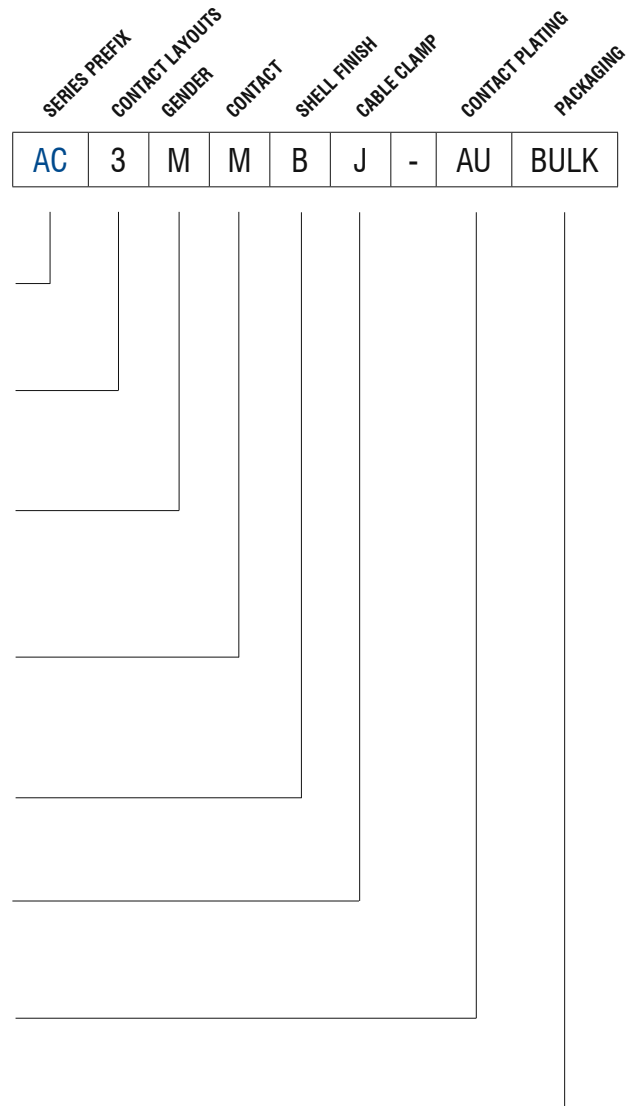

Note:

¹ 4 - 7 contact connectors have machined contacts and grounding as standard.

² Ground contacts are not supplied with the black polyester finish shell option.

³ 7 Contact is gold plated as standard.

⁴ All AC Series Connectors are available with optional colour coded boot / backshell. Refer to page 136 and simply add colour to end of part number. Example: AC3MM - RED

XLR Connectors

AC Series XLR Cable Connectors





Features:

- Thermoplastic Shell.
- Solder Bucket Connections.
- "Jaws" Cable Retention System.
- Stamped or Machined Contacts.
- Leading first mate last break socket contact.
- Quick and easy assembly without screws – by hand or portable termination tool. (Part number T2860.)

Options: Gold Plated Contacts, Stamped Contacts (3 Contact only), Bulk Pack, Coloured Boots / Backshells 3, 4, 5, 6A and 7 Contacts.

Specifications: Page 15

PRODUCT - FIGURE	DRAWING	DESCRIPTION	VARIATIONS	PART NUMBER
		XLR 3 pole male, Machined contacts, Thermoplastic shell, Jaws cable clamp	Standard	AC3MMCP
			Bulk Pack	AC3MMCP BULK
		XLR 3 pole male, Stamped contacts, Thermoplastic shell, Jaws cable clamp	Standard	AC3MCP
			Bulk Pack	AC3MCP BULK
		XLR 3 pole female, Stamped contacts, Thermoplastic shell, Jaws cable clamp	Standard	AC3FCP
			Bulk Pack	AC3FCP BULK

Note: Thermoplastic shell connectors are also available in 4 - 7 contact arrangements, please contact us for ordering code.

STANDARD DATA AC CABLE CONNECTORS

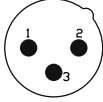
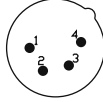
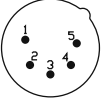
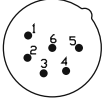
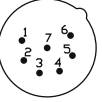
		VALUE				
GENERAL CHARACTERISTICS	Number of contacts	3	4	5	6A	7
	AC Series Contact Arrangements (Front view of pin inserts)					
	Termination	SOLDER				
	Max. Wire Gauge - Stranded wire: Solder	14AWG	16AWG	18AWG		20AWG
	Flammability rating (insulator plastics & housings)	UL94V-0				
	Environmental	Complies with EU RoHS 2 Directive 2011/65/EU				
ELECTRICAL CHARACTERISTICS	Service Voltage RMS	133V ¹				
	Test Voltage AC RMS	1400V				
	Current carrying capacity: Solder	15A	10A	7.5A		5A
	Typical Contact Resistance	≤3mΩ				
	Insulation Resistance	≥1GΩ				
CLIMATIC CHARACTERISTICS	Protection Class	IP40				
	Operating Temperature	-25 °C to +75 °C (-13°F to +167°F)				
MECHANICAL CHARACTERISTICS	Insertion and Withdrawal force	≥ 10N - ≤30N				
	Weight - Metal ²	36g (0.080lb)	37g (0.081lb)	38g (0.083lb)		
	Weight - Thermoplastic ²	18g (0.039lb)	19g (0.041lb)	20g (0.044lb)		
	Typical Cable retention force	22Kg to 44Kg (50lb to 100lb) - Dependent on cable material and diameter.				
	Cable O.D. range - JAWS clamp	Standard	3mm to 6.5mm (0.118" to 0.255")			
		Large	6.5mm to 8mm (0.255" to 0.314")			
	Mechanical Operations	1000 mating cycles				
MATERIALS	Connector shell - Metal	Diecast Zinc Alloy				
	Shell finish	Satin nickel or Black polyester				
	Connector shell - Thermoplastic	Thermoplastic, UL94V-0 Modified PPE Resin				
	Shell finish	Black				
	Insulators	UL94V-0 PBT Resin or Modified PPE Resin				
	Boot / Backshell	UL94V-0 Modified PPE Resin or Machined Brass				
	Finish	Black, other colours available - see page 136				
	Cable clamp (JAWS)	Standard Solder	UL94V-0 Modified PPO Resin (Black)			
	Large Solder	UL94V-0 Modified PPO Resin (Purple)				
	Cable Bushing	Santoprene				
Male Contact (Solder / Plating)	Stamped	Phosphor Bronze / Silver or Gold (Optional)				
	Machined	Brass / Silver or Gold (Optional)				
Female Contact (Solder / Plating)	Stamped	Phosphor Bronze / Tin or Gold (Optional)				
	Machined	Brass / Silver or Gold (Optional)				

Rev 6 - 03/2015

¹ Not suitable for domestic applications above 50V

² Approximate weight only, does not include packaging. Please contact us for exact weight for shipping purposes.

XLR Connectors

AC/AX Series XLR Metal Chassis Mount Connectors



AC/AX SERIES XLR METAL CHASSIS MOUNT CONNECTORS

The metal chassis mount connectors are designed for the audio user where durability, reliability and strength across a wide range of applications are important. All products are manufactured to the highest quality standards and will withstand the harshest environments. This range complies with IEC268-12 and AES 14-1992 standards. CSA File Number 68598

Features

- The "D" size housing can be either front or rear mounted using the same panel cutout.
- The "P" size housing is the original wide flange front mounting XLR connector. "PN" is the original narrow flange front mounting male connector.
- A leading first mate last break socket contact is standard on all female connectors (Pin 1).
- Solder cup or Vertical PCB versions.
- Connectors are fitted with a grounding system for RFI shielding applications.
- Available in 3, 4, 5, 6A and 7 contact arrangements.
- Compatible with all other XLR brands.

Options

- Solder Bucket termination
- Vertical PCB contacts
- Zinc Diecast Shell - Satin Nickel Finish
- Zinc Diecast Shell - Black Polyester Finish
- Gold, Silver or Tin Plated Contacts
- Bulk Packaging
- Single Bag packs
- Precision machined contacts
- Cost effective stamped contacts on 3 pole
- Latchless versions (Non-Latching) (Female only)

Note: A ground tag is standard on all AC "Z" series connectors. Although the ground tag is intended for RFI shielding applications, Amphenol cannot guarantee its effectiveness in all cases.

The non-conductive Black polyester finish insulates the ground tag from the shell and should not be used in applications requiring ground contact to the shell.

Ordering Codes

We have listed the more common ordering codes in each section. For further options please refer to the part number breakdown charts. Please contact us if you need any further assistance.

Simple steps to guide you in using this catalogue

- 1) Identify the product group listed in Contents on page 1 and go directly to that page number.
- 2) Each product group cover page then details information and options available.
- 3) Refer to the product detail pages and identify the product you require pictorially.
- 4) Read the product description column for the products standard features.
- 5) Use variations column to determine your choice.
- 6) Identify part number.
- 7) In the event the particular option you require is not listed please refer to the part number breakdown page at the end of each section.
- 8) Please contact us directly if you have any further problems.

XLR Connectors

AC/AX Series XLR Metal Chassis Mount Connectors







Features:

- Zinc Diecast Shell.
- D size housing can be front or rear mounted using the same panel cutout.
- Solder Bucket connections.
- Vertical PCB mounting.
- Precision machined or Stamped contacts (3 pin only).
- Leading first mate last break socket contact.
- Positive latch lock system.
- M3 threaded holes (Optional).

Options: Stamped contacts (3 contact only), Gold plated contacts, Vertical PCB contacts, Black finish, Non-Latching (Female only), Bulk Pack.

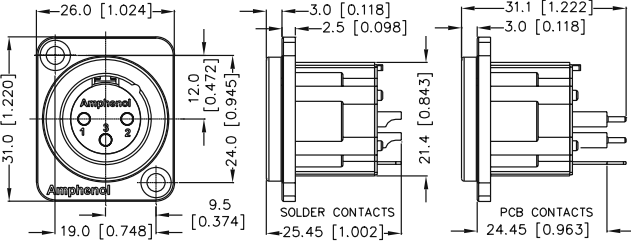

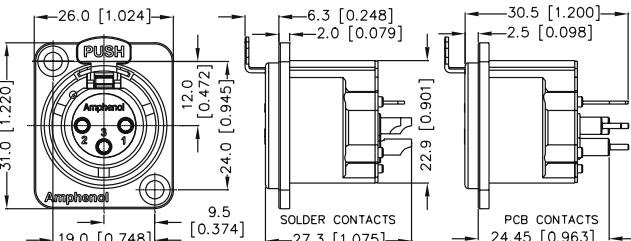



Part Number Breakdown: Page 20

Specifications: Page 26

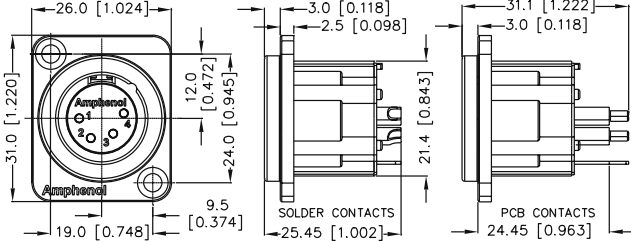
PRODUCT	DRAWING Dimensions in mm (inches)	DESCRIPTION	VARIATIONS	PART NO.	
		XLR 3 pole male, D Flange, Machined contacts, Nickel Finish	Standard	AX3MD	
			M3 Threaded Holes	AX3MD-M3	
				Vertical PCB	AX3MDV
				M3 Threaded Holes	AX3MDV-M3
		XLR 3 pole male, D Flange, Machined contacts, Black Finish	Standard	AX3MDB	
			M3 Threaded Holes	AX3MDB-M3	
			Gold Plated Contacts	AX3MDB-AU	
			Vertical PCB	AX3MDVB	
			M3 Threaded Holes	AX3MDVB-M3	
		XLR 3 pole female, D Flange, Stamped contacts, Nickel Finish	Standard	AX3FD	
				M3 Threaded Holes	AX3FD-M3
		XLR 3 pole female, D Flange, Stamped contacts, Black Finish	Standard	AX3FDB	
			M3 Threaded Holes	AX3FDB-M3	
			Gold Plated Contacts	AX3FDB-AU	

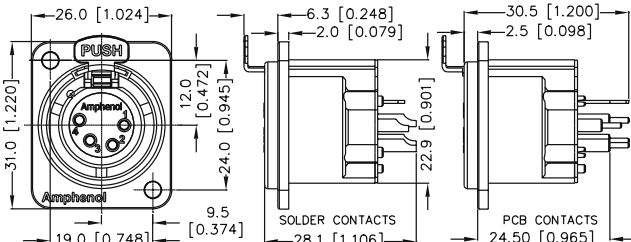

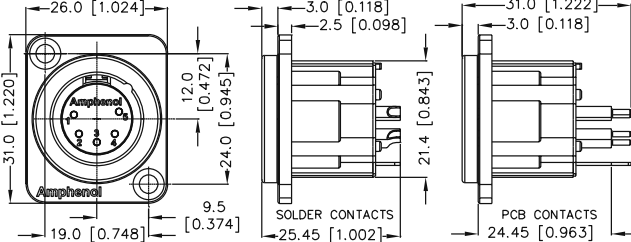



XLR Connectors

AC/AX Series XLR Metal Chassis Mount Connectors

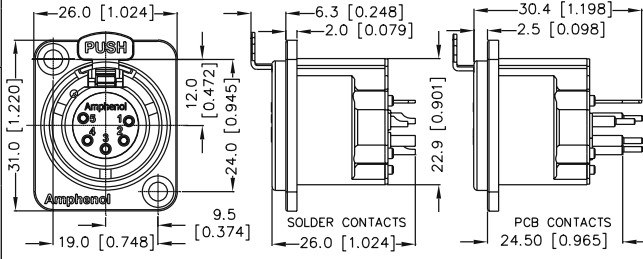
PRODUCT	DRAWING Dimensions in mm (inches)	DESCRIPTION	VARIATIONS	PART NO.	
		XLR 4 pole male, D Flange, Machined contacts, Nickel Finish	Standard	AX4MD	
M3 Threaded Holes			AX4MD-M3		
Vertical PCB			AX4MDV		
				M3 Threaded Holes	AX4MDV-M3
			XLR 4 pole male, D Flange, Machined contacts, Black Finish	Standard	AX4MDB
				Gold Plated Contacts	AX4MDB-AU
		Vertical PCB		AX4MDVB	
		XLR 4 pole female, D Flange, Machined contacts, Nickel Finish	Standard	AX4FD	
				M3 Threaded Holes	AX4FD-M3
				Vertical PCB	AX4FDV
				M3 Threaded Holes	AX4FDV-M3
			XLR 4 pole female, D Flange, Machined contacts, Black Finish	Standard	AX4FDB
				Gold Plated Contacts	AX4FDB-AU
		Vertical PCB		AX4FDBV	
		XLR 5 pole male, D Flange, Machined contacts, Nickel Finish	Standard	AX5MD	
				M3 Threaded Holes	AX5MD-M3
				Vertical PCB	AX5MDV
				M3 Threaded Holes	AX5MDV-M3
			XLR 5 pole male, D Flange, Machined contacts, Black Finish	Standard	AX5MDB
				Gold Plated Contacts	AX5MDB-AU
		Vertical PCB		AX5MDVB	

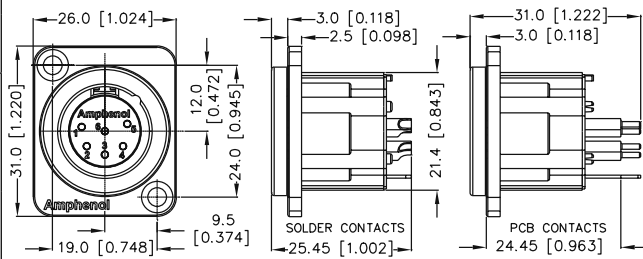
XLR Connectors

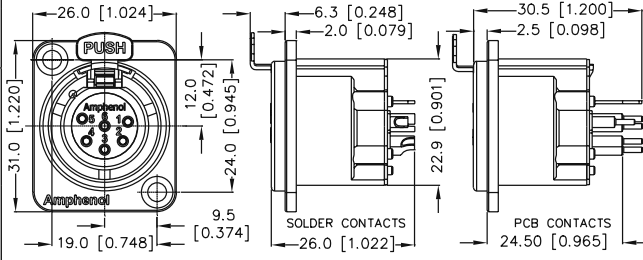
AC/AX Series XLR Metal Chassis Mount Connectors

PRODUCT	DRAWING Dimensions in mm (inches)	DESCRIPTION	VARIATIONS	PART NO.
		XLR 5 pole female, D Flange, Machined contacts, Nickel Finish	Standard M3 Threaded Holes	AX5FD AX5FD-M3
		Vertical PCB M3 Threaded Holes	AX5FDV AX5FDV-M3	
		XLR 5 pole female, D Flange, Machined contacts, Black Finish	Standard	AX4FDB
		Gold Plated Contacts Vertical PCB	AX4FDB-AU AX4FDBV	
		XLR 6A pole male, D Flange, Machined contacts, Nickel Finish	Standard M3 Threaded Holes	AX6AMD AX6AMD-M3
		Vertical PCB M3 Threaded Holes	AX6AMDV AX6AMDV-M3	
		XLR 6A pole male, D Flange, Machined contacts, Black Finish	Standard	AX6AMDB
		Gold Plated Contacts Vertical PCB	AX6AMDB-AU AX6AMDBV	
		XLR 6A pole female, D Flange, Machined contacts, Nickel Finish	Standard M3 Threaded Holes	AX6AFD AX6AFD-M3
		Vertical PCB M3 Threaded Holes	AX6AFDV AX6AFDV-M3	
		XLR 6A pole female, D Flange, Machined contacts, Black Finish	Standard	AX6AFDB
		Gold Plated Contacts Vertical PCB	AX6AFDB-AU AX6AFDBV	

XLR Connectors

AC/AX Series XLR Metal Chassis Mount Connectors

PART NUMBER BREAKDOWN

METAL TYPE FLANGE

E. G. **AX3MDVB-AU-M3 BULK**
AX (Series Prefix), **3** contacts, **M**ale, **D** Small Flange, **V**ertical PCB Contact,
Black Polyester Finish, - **AU** (Gold Plated Contacts), - **M3** Mounted Holes,
BULK Packaged.

SERIES PREFIX	AX	=	Series Prefix
CONTACT LAYOUTS	3	=	3 Contacts
	4	=	4 Contacts
	5	=	5 Contacts
	6A	=	6 Contacts
GENDER	F	=	Female Socket Contacts
	M	=	Male Pin Contacts
SHELL STYLE	D	=	Small Flange (front or rear mounting)
SHELL SERIES	Blank	=	Solder Bucket
	V	=	Vertical PCB Contact
SHELL FINISH¹	Blank	=	Nickel Plated Finish
	B	=	Black Polyester Finish
CONTACT PLATING²	Blank	=	Standard Plating
	AU	=	Gold Plated
MOUNTING HOLES	Blank	=	Through Holes
	M3	=	M3 Threaded Holes
PACKAGING	Blank	=	Individual Bags
	BULK	=	Bulk Packed

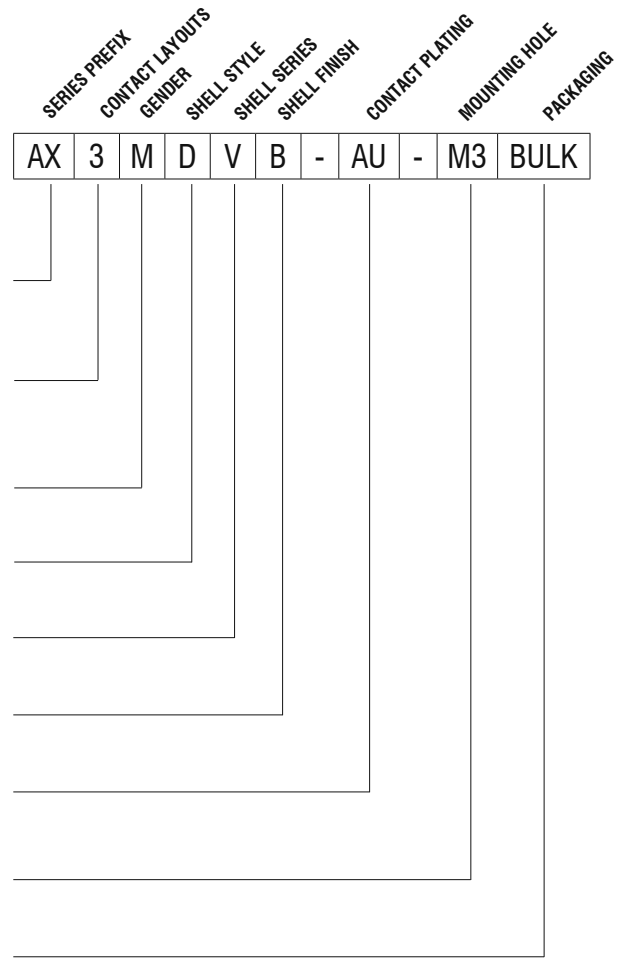

Note:

¹ Ground contacts are not supplied with the black polyester finish shell option.

³ Non-Latching Versions (Female) available - Please contact us for part number options.

XLR Connectors

AC/AX Series XLR Metal Chassis Mount Connectors



Features:

- Zinc Diecast Shell.
- D size housing can be front or rear mounted using the same panel cutout.
- Solder Bucket connections.
- Precision machined or Stamped contacts (3 pin only).
- Leading first mate last break socket contact.
- Positive latch lock system.

Options: Stamped contacts (3 contact only), Gold plated contacts, Black finish, Non-Latching (Female only), Bulk Pack.

Part Number Breakdown: [Page 25](#)

Specifications: [Page 26](#)











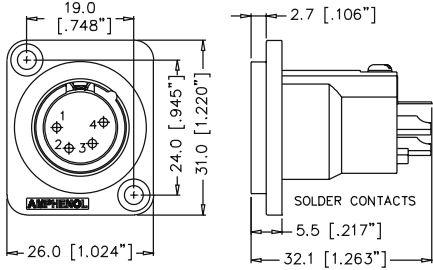

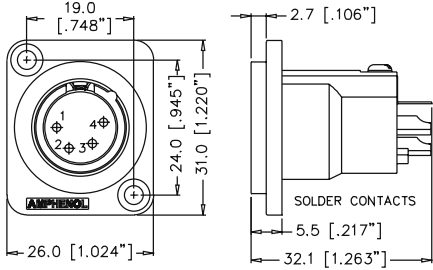

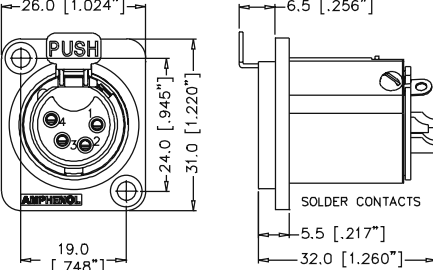
PCB Footprints: [Page 27](#)

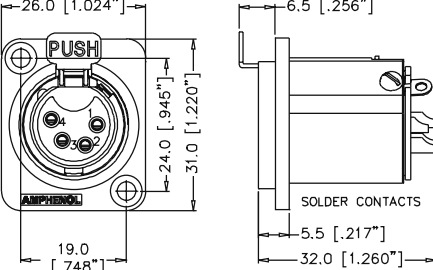
Panel Cutouts: [Page 27](#)

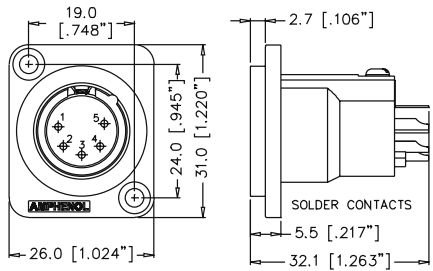
PRODUCT - FIGURE	DRAWING	Dimensions in mm (inches)	DESCRIPTION	VARIATIONS	PART NUMBER
	<p>19.0 [.748"] 24.0 [.945"] 31.0 [1.220"] 26.0 [1.024"] 2.7 [.106"] 5.5 [.217"] 32.1 [1.263"] SOLDER CONTACTS</p>		XLR 3 pole male, D Flange, Machined contacts, Nickel Finish	Standard	AC3MMDZ
				Bulk Pack	AC3MMDZ BULK
	<p>19.0 [.748"] 24.0 [.945"] 31.0 [1.220"] 26.0 [1.024"] 2.7 [.106"] 5.5 [.217"] 32.1 [1.263"] SOLDER CONTACTS</p>		XLR 3 pole male, D Flange, Machined contacts, Black Finish	Standard	AC3MMDZB
				Gold Plated Contacts	AC3MMDZB-AU
	<p>19.0 [.748"] 24.0 [.945"] 31.0 [1.220"] 26.0 [1.024"] 2.7 [.106"] 5.5 [.217"] 32.1 [1.263"] SOLDER CONTACTS</p>		XLR 3 pole male, D Flange, Stamped contacts, Nickel Finish	Standard	AC3MDZ
				Bulk Pack	AC3MDZ BULK
	<p>19.0 [.748"] 24.0 [.945"] 31.0 [1.220"] 26.0 [1.024"] 2.7 [.106"] 5.5 [.217"] 32.1 [1.263"] SOLDER CONTACTS</p>		XLR 3 pole male, D Flange, Stamped contacts, Black Finish	Standard	AC3MDZB
				Gold Plated Contacts	AC3MDZB-AU
	<p>26.0 [1.024"] 19.0 [.748"] 24.0 [.944"] 31.0 [1.220"] 6.5 [.256"] 5.5 [.217"] 33.5 [1.319"] SOLDER CONTACTS</p>		XLR 3 pole female, D Flange, Stamped contacts, Nickel Finish	Standard	AC3FDZ
				Bulk Pack	AC3FDZ BULK
	<p>26.0 [1.024"] 19.0 [.748"] 24.0 [.944"] 31.0 [1.220"] 6.5 [.256"] 5.5 [.217"] 33.5 [1.319"] SOLDER CONTACTS</p>		XLR 3 pole female, D Flange, Stamped contacts, Black Finish	Standard	AC3FDZB
				Gold Plated Contacts	AC3FDZB-AU

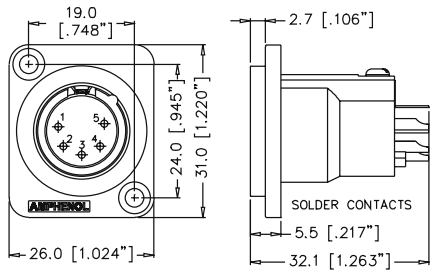

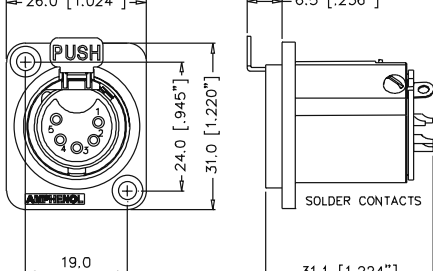

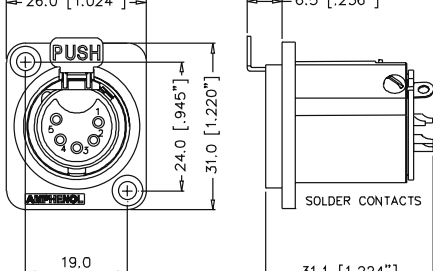





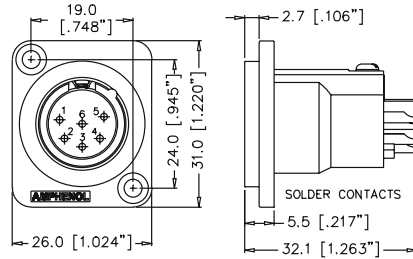

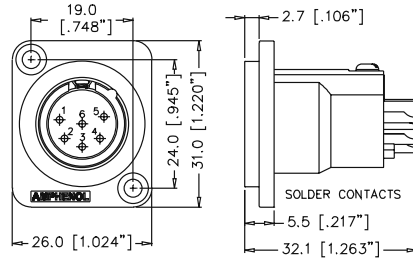

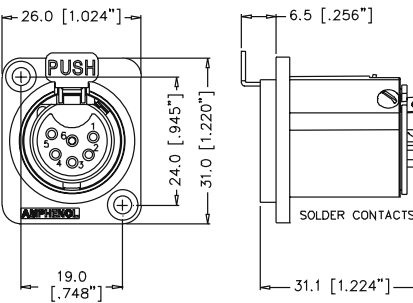
XLR Connectors

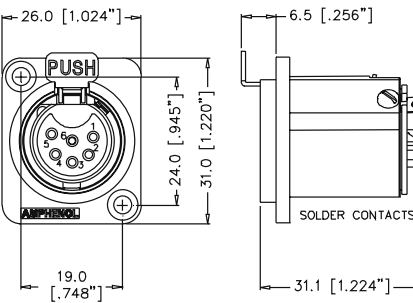
AC/AX Series XLR Metal Chassis Mount Connectors

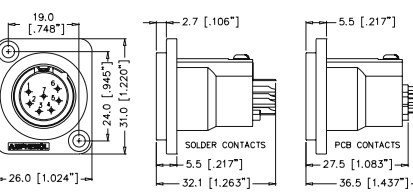
PRODUCT - FIGURE	DRAWING	Dimensions in mm (inches)	DESCRIPTION	VARIATIONS	PART NUMBER
		<p>2.7 [.106"]</p> <p>SOLDER CONTACTS</p> <p>5.5 [.217"]</p> <p>32.1 [1.263"]</p>	<p>XLR 4 pole male, D Flange, Machined contacts, Nickel Finish</p>	Standard	AC4MDZ
				Bulk Pack	AC4MDZ BULK
		<p>2.7 [.106"]</p> <p>SOLDER CONTACTS</p> <p>5.5 [.217"]</p> <p>32.1 [1.263"]</p>	<p>XLR 4 pole male, D Flange, Machined contacts, Black Finish</p>	Standard	AC4MDZB
				Gold Plated Contacts	AC4MDZB-AU
		<p>6.5 [.256"]</p> <p>SOLDER CONTACTS</p> <p>5.5 [.217"]</p> <p>32.0 [1.260"]</p>	<p>XLR 4 pole female, D Flange, Machined contacts, Nickel Finish</p>	Standard	AC4FDZ
				Bulk Pack	AC4FDZ BULK
		<p>6.5 [.256"]</p> <p>SOLDER CONTACTS</p> <p>5.5 [.217"]</p> <p>32.0 [1.260"]</p>	<p>XLR 4 pole female, D Flange, Machined contacts, Black Finish</p>	Standard	AC4FDZB
				Gold Plated Contacts	AC4FDZB-AU
		<p>2.7 [.106"]</p> <p>SOLDER CONTACTS</p> <p>5.5 [.217"]</p> <p>32.1 [1.263"]</p>	<p>XLR 5 pole male, D Flange, Machined contacts, Nickel Finish</p>	Standard	AC5MDZ
				Bulk Pack	AC5MDZ BULK
		<p>2.7 [.106"]</p> <p>SOLDER CONTACTS</p> <p>5.5 [.217"]</p> <p>32.1 [1.263"]</p>	<p>XLR 5 pole male, D Flange, Machined contacts, Black Finish</p>	Standard	AC5MDZB
				Gold Plated Contacts	AC5MDZB-AU
		<p>6.5 [.256"]</p> <p>SOLDER CONTACTS</p> <p>5.5 [.217"]</p> <p>31.1 [1.224"]</p>	<p>XLR 5 pole female, D Flange, Machined contacts, Nickel Finish</p>	Standard	AC5FDZ
				Bulk Pack	AC5FDZ BULK
		<p>6.5 [.256"]</p> <p>SOLDER CONTACTS</p> <p>5.5 [.217"]</p> <p>31.1 [1.224"]</p>	<p>XLR 5 pole female, D Flange, Machined contacts, Black Finish</p>	Standard	AC5FDZB
				Gold Plated Contacts	AC5FDZB-AU

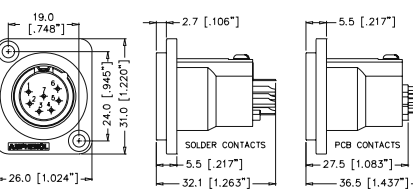
XLR Connectors

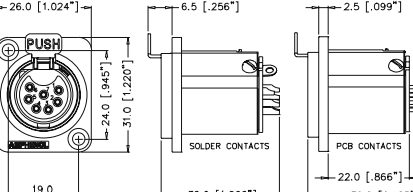
AC/AX Series XLR Metal Chassis Mount Connectors

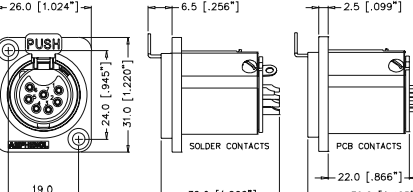
PRODUCT - FIGURE	DRAWING	Dimensions in mm (inches)	DESCRIPTION	VARIATIONS	PART NUMBER
			XLR 6A pole male, D Flange, Machined contacts, Nickel Finish	Standard	AC6AMDZ
				Bulk Pack	AC6AMDZ BULK
			XLR 6A pole male, D Flange, Machined contacts, Black Finish	Standard	AC6AMDZB
				Gold Plated Contacts	AC6AMDZB-AU
			XLR 6A pole female, D Flange, Machined contacts, Nickel Finish	Standard	AC6AFDZ
				Bulk Pack	AC6AFDZ BULK
			XLR 6A pole female, D Flange, Machined contacts, Black Finish	Standard	AC6AFDZB
				Gold Plated Contacts	AC6AFDZB-AU
			XLR 7 pole male, D Flange, Gold Plated Machined contacts, Nickel Finish	Standard	AC7MDZ
				Vertical PCB	AC7MDZV
				Bulk Pack	AC7MDZ BULK
			XLR 7 pole male, D Flange, Gold Plated Machined contacts, Black Finish	Standard	AC7MDZB
				Vertical PCB	AC7MDZVB
			XLR 7 pole female, D Flange, Gold Plated Machined contacts, Nickel Finish	Standard	AC7FDZ
				Vertical PCB	AC7FDZV
				Bulk Pack	AC7FDZ BULK
			XLR 7 pole female, D Flange, Gold Plated Machined contacts, Black Finish	Standard	AC7FDZB
				Vertical PCB	AC7FDZVB

XLR Connectors

AC/AX Series XLR Metal Chassis Mount Connectors



Features:

- Zinc Diecast shell.
- The P size housing is the original wide flange front mounting XLR connector. PN is the original narrow, front mounting male connector.
- Solder Bucket connections.
- Precision Machined or Stamped contacts (3 pin only).
- Leading first mate last break socket contact.
- Positive latch lock system.

Options: Stamped contacts (3 contact only), Gold plated contacts, Black Finish, Non-Latching (Female only), Bulk Pack.

Part Number Breakdown: Page 20 Specifications: Page 26
PCB Footprints: Page 27 Panel Cutouts: Page 27

PRODUCT - FIGURE	DRAWING	Dimensions in mm (inches)	DESCRIPTION	POLES	PART NUMBER
		2.4 [.094"] 27.0 [1.063"] 36.8 [1.449"] 22.2 [.874"] 32.1 [1.265"]	XLR male, Narrow flange, Machined contacts	3	AC3MMPNZ
		2.4 [.094"] 27.0 [1.063"] 36.8 [1.449"] 22.2 [.874"] 32.1 [1.265"]	XLR male, Narrow flange, Stamped contacts,	3 4 5 6 7	AC3MPNZ AC4MPNZ AC5MPNZ AC6AMPNZ AC7MPNZ
		2.4 [.094"] 27.2 [1.070"] 36.7 [1.445"] 26.4 [1.039"] 16.7 [.656"] 31.5 [1.238"]	XLR male, Wide flange, Machined contacts	3	AC3MMP
		2.4 [.094"] 27.2 [1.070"] 36.7 [1.445"] 26.4 [1.039"] 16.7 [.656"] 32.5 [1.278"]	XLR male, Wide flange, Stamped contacts	3 4 5 6 7	AC3MP AC4MP AC5MP AC6AMP AC7MP
		3.5 [.138"] 27.2 [1.070"] 36.7 [1.445"] 26.4 [1.039"] 16.7 [.656"] 2.5 [.098"] 31.0 [1.220"]	XLR female, Wide flange, Stamped contacts	3 4 5 6 7	AC3FPZ AC4FPZ AC5FPZ AC6AFPZ AC7FPZ

*Black finish available on special request please contact factory.

PART NUMBER BREAKDOWN

METAL TYPE FLANGE

E. G. **AC3MMPNZVB-AU BULK**
AC (Series Prefix), **3** contacts, **Male**, **Machined Contacts**, **PN** (Narrow Flange), **Z** (Metal Chassis Series), **Black Polyester Finish**, **- AU** (Gold Plated Contacts), **Bulk** Packaged.

SERIES PREFIX	AC	=	Series Prefix
CONTACT LAYOUTS	3	=	3 Contacts
	4	=	4 Contacts
	5	=	5 Contacts
	6A	=	6 Contacts
	7	=	7 Contacts
GENDER	F	=	Female Socket Contacts
	M	=	Male Pin Contacts
MACHINED CONTACTS¹	Blank	=	Stamped Contacts
	M	=	Machined Contacts (Applicable 3 male pin contacts only)
SHELL STYLE	D	=	Small Flange (front or rear mounting)
	P	=	Large Shell with Wide Flange
	PN	=	Large Shell with Narrow Flange (male only)
SHELL SERIES	Blank	=	Male P Shell Style Only
	Z	=	Metal Chassis Series
SHELL FINISH²	Blank	=	Nickel Plated Finish
	B	=	Black Polyester Finish
CONTACT PLATING³	Blank	=	Standard Plating (Silver or Tin - refer to Standard Data)
	AU	=	Gold Plated
PACKAGING	Blank	=	Individual Bags
	BULK	=	Bulk Packed

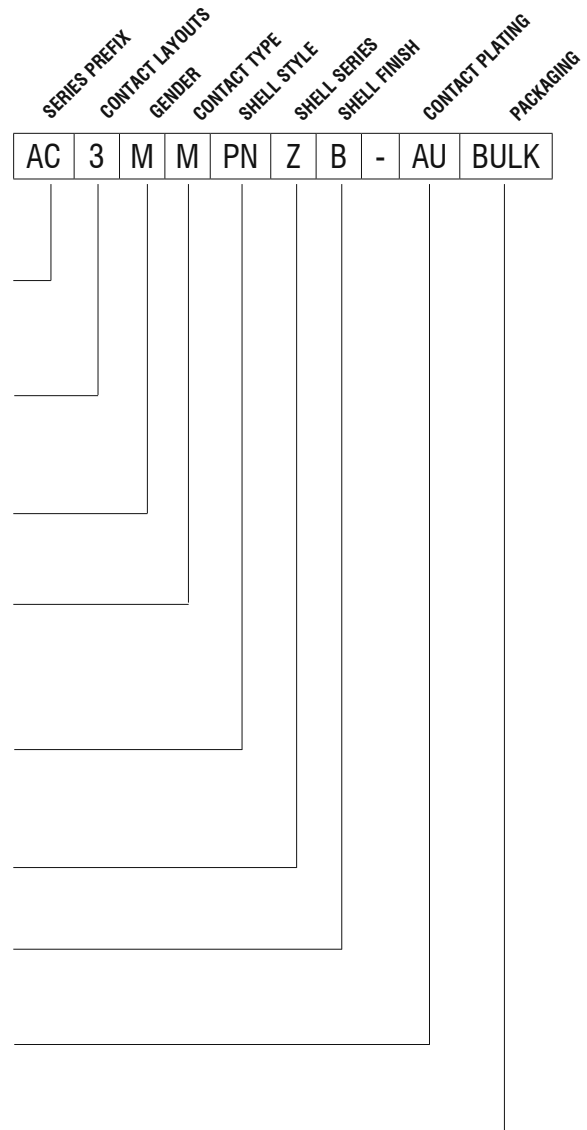

Note:

¹ 4 - 7 contact connectors have machined contacts and grounding as standard. They are not available in stamped contacts.

² Ground contacts are not supplied with the black polyester finish shell option.

³ 7 Contact is gold plated as standard.

⁴ Non-Latching Versions (Female) available - Please contact us for part number options.

XLR Connectors

AC/AX Series XLR Metal Chassis Mount Connectors

STANDARD DATA AC / AX SERIES CHASSIS - METAL “Z”

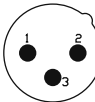
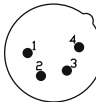
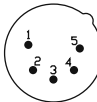
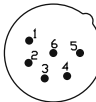
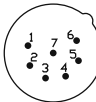
		VALUE				
GENERAL CHARACTERISTICS	Number of contacts	3	4	5	6A	7
	Contact Arrangement (Front view of pin inserts)					
	Termination	Solder Bucket / Printed Circuit Board (PCB)				
	Max. Wire Gauge - Stranded wire:					
	Solder	14AWG	16AWG	18AWG	18AWG	20AWG
	Printed Circuit Board - PCB	N/A	N/A	N/A	N/A	N/A
Flammability rating of plastics	UL94V-0					
Environmental	Complies with EU RoHS 2 Directive 2011/65/EU					
ELECTRICAL CHARACTERISTICS	Service Voltage RMS	133V ¹⁾				
	Test Voltage AC RMS	1400V				
	Current carrying capacity:					
	Solder	15A	10A	7.5A	7.5A	5A
	Printed Circuit Board (PCB)	15A	10A	7.5A	7.5A	5A
	Typical Contact Resistance	≤3mΩ				
Insulation Resistance	≥1000MΩ					
CLIMATIC CHARACTERISTICS	Protection Class	IP40				
	Operating Temperature	-25 °C to +75 °C (-13°F to +167°F)				
MECHANICAL CHARACTERISTICS	Weight - Metal ²⁾	31g (0.068lb)	32g (0.070lb)	33g (0.072lb)	33g (0.072lb)	33g (0.072lb)
	Mechanical Operations	1000 mating cycles				
MATERIALS	Connector Shell	Diecast Zinc Alloy				
	Shell Finish	Satin Nickel or Black Polyester				
	Insulators	PA66 30% Glass Filled Resin				
	Male Contact					
	Stamped Solder and PCB-(Material/Plating)	Phosphor Bronze / Silver or Gold (optional)				
	Machined Solder-(Material/Plating)	Brass / Silver or Gold (optional)				
	Female Contact					
Stamped Solder and PCB-(Material/Plating)	Phosphor Bronze / Tin or Gold (optional)					
Machined Solder-(Material/Plating)	Brass / Silver or Gold (Optional)					

Rev 4 - 02/2020

¹⁾ Not suitable for domestic applications above 50V

²⁾ Approximate weight only, does not include packaging. Please contact us for exact weight for shipping purposes.

AC / AX SERIES CHASSIS METAL "Z"

PCB FOOTPRINTS STRAIGHT (V) CONNECTOR SIDE OF PCB

○ $\varnothing 1.2\text{mm}(.05")$ + Panel Cutout CL

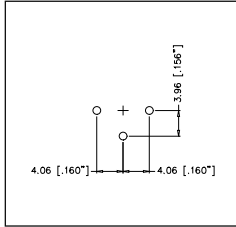

AC3MM*ZV

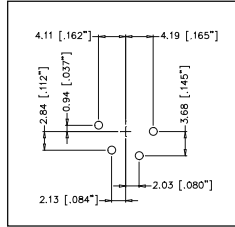

AC4F*ZV

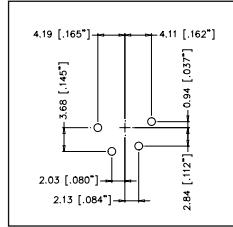

AC4M*ZV

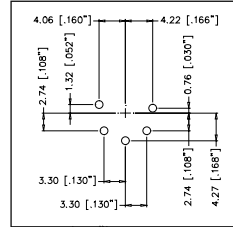

AC5F*ZV

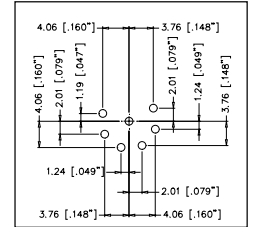

AC7M*ZV

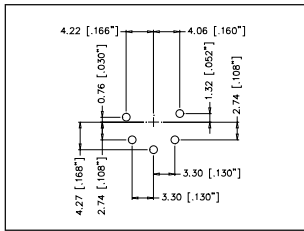

AC5M*ZV

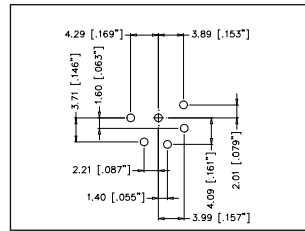

AC6AF*ZV

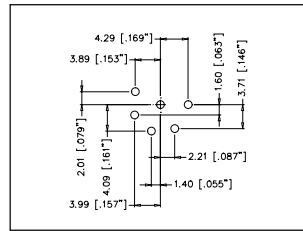

AC6AM*ZV

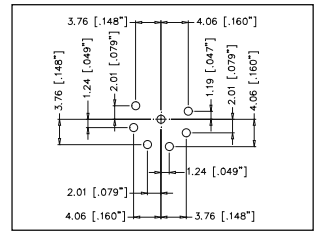

AC7F*ZV

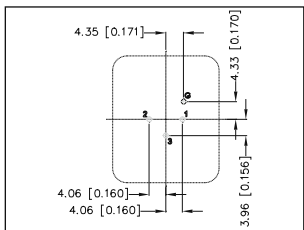

AX3FD

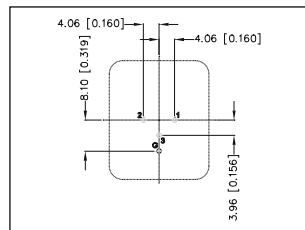

AX3MD

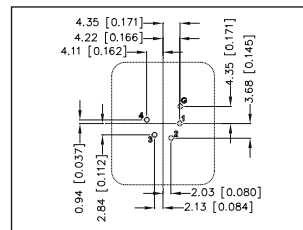

AX4FD

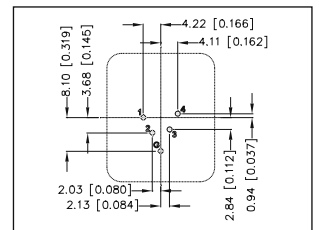

AX4MD

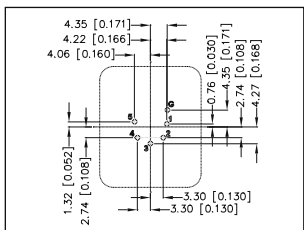

AX5FD

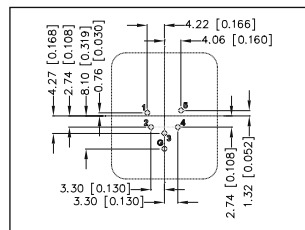

AX5MD

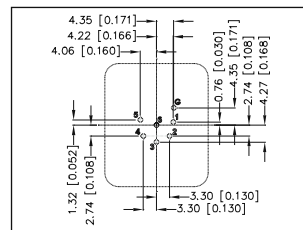

AX6AFD

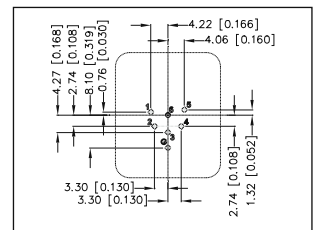

AX6AMD

PANEL CUTOUT DIMENSIONS FRONT VIEW

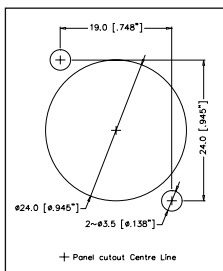

AC*FDZ / AX*FD

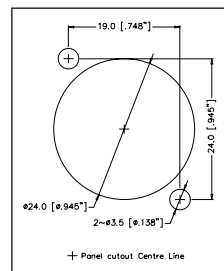

AC*MDZ / AX*MD

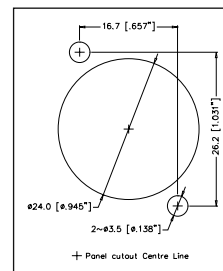

AC*FPZ

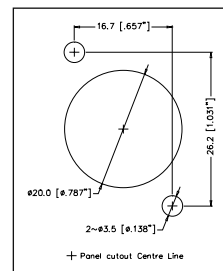

AC*MP

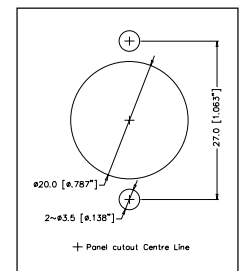

AC*MPNZ

XLR Connectors

AC Series XLR PCB Chassis Mount Connectors



AC SERIES XLR PCB CHASSIS MOUNT CONNECTORS

The AC series, A and B type XLR chassis receptacles have been designed and manufactured with the Original Equipment Manufacturers' (OEM) needs in mind. The compact shell design allows a significant space saving over the traditional 'D' type shell. Gold plated contacts improve the performance, ensuring a reliable contact and the unique grounding link options offer flexibility in design.

Features

- A leading first mate last break socket contact is standard on all female connectors (Pin 1).
- Vertical and Horizontal PCB versions available.
- Latching and Non-latching versions available.
- A range of different grounding options are available including:
 - Mating connector shell to Pin 1
 - Mating connector shell to Chassis
 - Mating connector shell to pin 1 to Chassis
- A type is available in 3, 4 or 5 contacts.
- B type is available in 3 contact only.
- Compatible with all other XLR brands.
- Metal Mounting Flange (B type)

Options

- Vertical PCB contacts
- Horizontal PCB contacts
- Precision Machined Pin contacts
- Cost effective Stamped Socket contacts
- Gold Plated contacts (Standard)
- Silver Plated contacts (Optional)
- Bulk Packaging
- Integrated Switch

Ordering Codes

We have listed the more common ordering codes in each section. For further options please refer to the part number breakdown charts. Please contact us if you need any further assistance.

Simple steps to guide you in using this catalogue

- 1) Identify the product group listed in Contents on page 1 and go directly to that page number.
- 2) Each product group cover page then details information and options available.
- 3) Refer to the product detail pages and identify the product you require pictorially.
- 4) Read the product description column for the products standard features.
- 5) Use variations column to determine your choice.
- 6) Identify part number.
- 7) In the event the particular option you require is not listed please refer to the part number breakdown page at the end of each section.
- 8) Please contact us directly if you have any further problems.

A TYPE

Features:

- Thermoplastic Shell
- Contact layouts in 3,4 or 5
- Industry standard PCB footprints.
- Vertical or Horizontal PCB mounting.
- Precision machined pin contacts.
- Gold plated contacts.
- Leading first mate last break socket contact.
- Bulk packed in trays, 100 to a box as standard.
- Positive latch lock system.

Options: Vertical or Horizontal PCB, Various grounding methods, Latching or Non-Latching.

Part Number Breakdown: [Page 36](#) **Specifications:** [Page 39](#)

PCB Footprints: [Page 40](#)

Panel Cutouts: [Page 41](#)

Recommended Fastener: [Page 134](#)



PRODUCT - FIGURE	DRAWING	Dimensions in mm (inches)	DESCRIPTION	GROUND LINK VARIATIONS	PART NUMBER
			XLR 3 pole male, Vertical PCB, Gold Plated Contacts, Bulk Pack	No Ground Link	AC3MAH-AU-PRE
			XLR 3 pole male, Horizontal PCB, Gold Plated Contacts, Bulk Pack	Pin 1 to Chassis to Mating connector shell	AC3MAH1-AU-PRE
			XLR 3 pole male, Horizontal PCB, Gold Plated Contacts, Bulk Pack	Mating connector shell to Chassis - Pin 1 sep. Ground	AC3MAH2-AU-PRE
			XLR 3 pole male with integrated switch, Horizontal PCB, Gold Plated Contacts, Bulk Pack	Mating connector shell to Chassis to PCB, Pin 1 sep. Ground	AC3MAH4-SW-B
			XLR 3 pole male, Vertical PCB, Gold Plated Contacts, Bulk Pack	No Ground Link	AC3MAV-AU-PRE











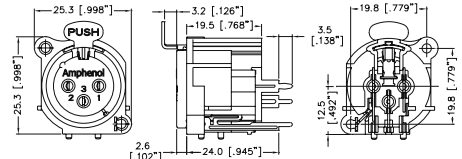

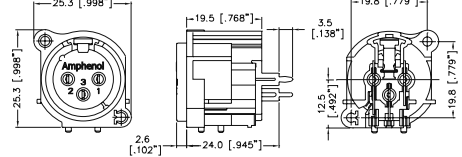

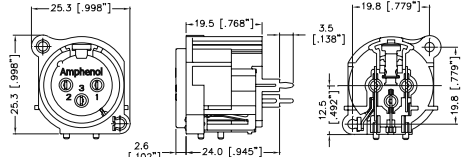

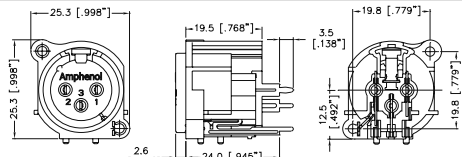
XLR Connectors

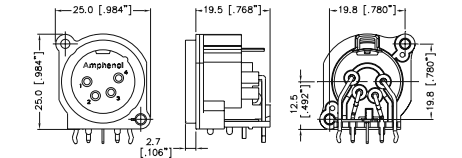
AC Series XLR PCB Chassis Mount Connectors

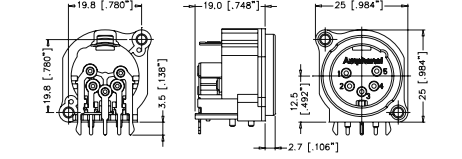
PRODUCT - FIGURE	DRAWING	Dimensions in mm (inches)	DESCRIPTION	GROUND LINK VARIATIONS	PART NUMBER
		25.4 [998"] 25.4 [998"] 24.0 [945"] 19.5 [768"] 19.8 [780"] 2.7 [106"] 3.5 [138"] 19.8 [780"] 19.8 [780"]	XLR 3 pole male, Vertical PCB, Gold Plated Contacts, Bulk Pack	Mating connector shell to Chassis - Pin 1 sep. Ground	AC3MAV2-AU-PRE
		25.4 [998"] 25.4 [998"] 24.0 [945"] 19.5 [768"] 19.8 [780"] 2.7 [106"] 19.8 [780"] 19.8 [780"]	XLR 3 pole male, Solder Buckets, Gold Plated Contacts, Bulk Pack	No Ground Link	AC3MA-AU-B
		25.4 [998"] 25.4 [998"] 3.2 [126"] 19.5 [768"] 19.8 [780"] 2.6 [102"] 12.5 [492"] 19.8 [780"] 19.8 [780"]	XLR 3 pole female, Horizontal PCB, Latching Type, Gold Plated Contacts, Bulk Pack	No Ground Link	AC3FAH-AU-PRE
		25.4 [998"] 25.4 [998"] 3.2 [126"] 19.5 [768"] 19.8 [780"] 2.6 [102"] 12.5 [492"] 19.8 [780"] 19.8 [780"]	XLR 3 pole female, Horizontal PCB, Latching Type, Gold Plated Contacts, Bulk Pack	Pin 1 to Chassis to Mating connector shell	AC3FAH1-AU-PRE
		25.4 [998"] 25.4 [998"] 3.2 [126"] 19.5 [768"] 19.8 [780"] 2.6 [102"] 12.5 [492"] 19.8 [780"] 19.8 [780"]	XLR 3 pole female, Horizontal PCB, Latching Type, Gold Plated Contacts, Bulk Pack	Mating connector shell to Chassis - Pin 1 sep. Ground	AC3FAH2-AU-PRE
		25.4 [998"] 25.4 [998"] 19.5 [768"] 19.8 [780"] 2.6 [102"] 12.5 [492"] 19.8 [780"] 19.8 [780"]	XLR 3 pole female, Horizontal PCB, Non-Latching Type Gold Plated Contacts, Bulk Pack	No Ground Link	AC3FAHL-AU-PRE
		25.4 [998"] 25.4 [998"] 19.5 [768"] 19.8 [780"] 2.6 [102"] 12.5 [492"] 19.8 [780"] 19.8 [780"]	XLR 3 pole female, Horizontal PCB, Non-Latching Type Gold Plated Contacts, Bulk Pack	Pin 1 to Chassis to mating connector shell	AC3FAHL1-AU-PRE
		25.4 [998"] 25.4 [998"] 19.5 [768"] 19.8 [780"] 2.6 [102"] 12.5 [492"] 19.8 [780"] 19.8 [780"]	XLR 3 pole female, Horizontal PCB, Non-Latching Type Gold Plated Contacts, Bulk Pack	Mating connector shell to Chassis - Pin 1 sep. Ground.	AC3FAHL2-AU-PRE
		25.3 [998"] 25.3 [998"] 3.2 [126"] 19.5 [768"] 19.8 [779"] 2.6 [102"] 24.0 [945"] 12.5 [492"] 3.5 [138"] 19.8 [779"] 19.8 [779"]	XLR 3 pole female, Vertical PCB, Latching Type, Gold Plated Contacts, Bulk Pack	No Ground Link	AC3FAV-AU-PRE
		25.3 [998"] 25.3 [998"] 3.2 [126"] 19.5 [768"] 19.8 [779"] 2.6 [102"] 24.0 [945"] 12.5 [492"] 3.5 [138"] 19.8 [779"] 19.8 [779"]	XLR 3 pole female, Vertical PCB, Latching Type, Gold Plated Contacts, Bulk Pack	Pin 1 to Chassis to Mating connector shell	AC3FAV1-AU-PRE

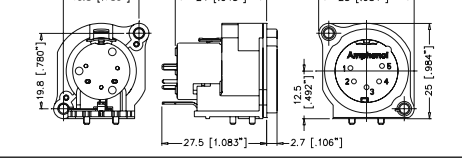
XLR Connectors

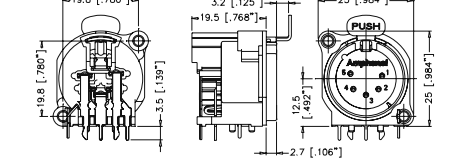
AC Series XLR PCB Chassis Mount Connectors

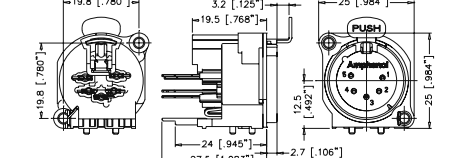
PRODUCT - FIGURE	DRAWING	Dimensions in mm (inches)	DESCRIPTION	GROUND LINK VARIATIONS	PART NUMBER
			XLR 3 pole female, Vertical PCB, Latching Type, Gold Plated Contacts, Bulk Pack	Mating connector shell to Chassis - Pin 1 sep. Ground.	AC3FAV2-AU-PRE
			XLR 3 pole female, Vertical PCB, Non-Latching Type, Gold Plated Contacts, Bulk Pack	No Ground Link	AC3FAVL-AU-PRE
			XLR 3 pole female, Vertical PCB, Non-Latching Type, Gold Plated Contacts, Bulk Pack	Pin 1 to Chassis to Mating connector shell	AC3FAVL1-AU-PRE
			XLR 3 pole female, Vertical PCB, Non-Latching Type, Gold Plated Contacts, Bulk Pack	Mating connector shell to Chassis - Pin 1 sep. Ground.	AC3FAVL2-AU-PRE
			XLR 4 pole male, Horizontal PCB, Gold Plated Contacts, Bulk Pack	Mating connector shell to Chassis - Pin 1 sep. Ground	AC4MAH-AU-B
			XLR 5 pole male, Horizontal PCB, Gold Plated Contacts, Bulk Pack	Mating connector shell to Chassis to PCB, Pin 1 sep. Ground	AC5MAH-AU-B
			XLR 5 pole male, Vertical PCB, Gold Plated Contacts, Bulk Pack	Mating connector shell to Chassis to PCB, Pin 1 sep. Ground	AC5MAV-AU-B
			XLR 5 pole female, Horizontal PCB, Gold Plated Contacts, Bulk Pack	Mating connector shell to Chassis to PCB, Pin 1 sep. Ground	AC5FAH-AU-B
			XLR 5 pole female, Vertical PCB, Gold Plated Contacts, Bulk Pack	Mating connector shell to Chassis to PCB, Pin 1 sep. Ground	AC5FAV-AU-B

XLR Connectors

AC Series XLR PCB Chassis Mount Connectors



B TYPE

Features:

- Thermoplastic Shell with Metal Mounting Flange
- Contact layouts in 3 or 5
- Industry standard PCB footprints
- Improved grounding performance
- Vertical or Horizontal PCB mounting
- Precision machined pin contacts
- Gold plated contacts
- Leading first mate last break socket contact
- Bulk packed in trays, 100 to a box as standard
- Positive latch lock system

Options: Silver plated contacts, Vertical or Horizontal PCB, Various grounding methods, Latching or Non-Latching.

Part Number Breakdown: [Page 36](#) **Specifications:** [Page 39](#)
PCB Footprints: [Page 40](#) **Panel Cutouts:** [Page 41](#)
Recommended Fastener: [Page 134](#)

PRODUCT - FIGURE	DRAWING	Dimensions in mm (inches)	DESCRIPTION/ GROUND LINK	MOUNTING FLANGE VARIATIONS	PART NUMBER
		25.3 [.996"] 19.5 [.768"] 19.8 [.780"] 12.5 [.492"] 2.7 [.106"] 3.5 [.139"]	XLR 3 pole male, Horizontal PCB, Gold Plated Contacts, Bulk Pack No Ground Link	Nickel Finish	AC3MBH-AU-PRE
		25.3 [.996"] 19.5 [.768"] 19.8 [.780"] 12.7 [.500"] 2.7 [.106"] 3.5 [.139"]	XLR 3 pole male, Horizontal PCB, Gold Plated Contacts, Bulk Pack Pin 1 to Chassis to Mating connector shell	Nickel Finish	AC3MBH1-AU-PRE
		25.3 [.996"] 19.5 [.768"] 19.8 [.780"] 12.5 [.492"] 2.7 [.106"] 3.5 [.136"]	XLR 3 pole male, Horizontal PCB, Gold Plated Contacts, Bulk Pack Mating connector shell to Chassis - Pin 1 sep. Ground	Nickel Finish	AC3MBH2-AU-PRE
		25.3 [.996"] 19.5 [.768"] 19.8 [.780"] 12.5 [.492"] 2.7 [.106"] 3.5 [.139"]	XLR 3 pole male, Horizontal PCB, Gold Plated Contacts, Bulk Pack Mating connector shell to Pin 1	Nickel Finish	AC3MBH3-AU-PRE
		25.3 [.996"] 19.5 [.768"] 19.8 [.780"] 12.5 [.492"] 2.7 [.106"] 3.5 [.139"]	XLR 3 pole male, Horizontal PCB, Non-Latching Type, Gold Plated Contacts, Bulk Pack No Ground Link	Nickel Finish	AC3MBHL-AU-PRE
		25.3 [.996"] 24.0 [.945"] 19.5 [.768"] 19.8 [.780"] 12.5 [.492"] 2.7 [.106"] 3.5 [.138"]	XLR 3 pole male, Vertical PCB, Gold Plated Contacts, Bulk Pack No Ground Link	Nickel Finish	AC3MBV-AU-PRE











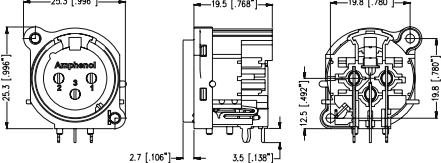

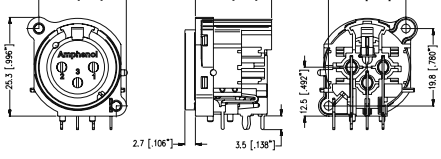

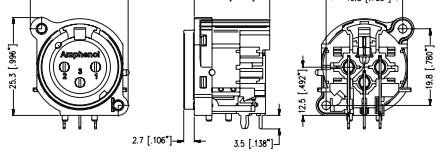
XLR Connectors

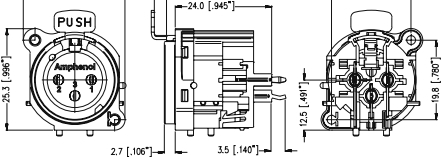
AC Series XLR PCB Chassis Mount Connectors

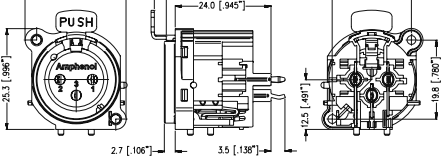
PRODUCT - FIGURE	DRAWING	Dimensions in mm (inches)	DESCRIPTION/ GROUND LINK	MOUNTING FLANGE VARIATIONS	PART NUMBER
			XLR 3 pole male, Vertical PCB, Gold Plated Contacts, Bulk Pack Pin 1 to Chassis to Mating connector shell	Nickel Finish	AC3MBV1-AU-PRE
			XLR 3 pole male, Vertical PCB, Gold Plated Contacts, Bulk Pack Mating connector shell to Chassis - Pin 1 sep. Ground	Nickel Finish	AC3MBV2-AU-PRE
			XLR 3 pole male, Vertical PCB, Gold Plated Contacts, Bulk Pack Mating connector shell to Pin 1	Nickel Finish	AC3MBV3-AU-PRE
			XLR 3 pole female, Horizontal PCB, Latching Type, Gold Plated Contacts, Bulk Pack No Ground Link	Nickel Finish	AC3FBH-AU-PRE
			XLR 3 pole female, Horizontal PCB, Latching Type, Gold Plated Contacts, Bulk Pack Pin 1 to Chassis to Mating connector shell	Nickel Finish	AC3FBH1-AU-PRE
			XLR 3 pole female, Horizontal PCB, Latching Type, Gold Plated Contacts, Bulk Pack Mating connector shell to Chassis - Pin 1 sep. Ground	Nickel Finish	AC3FBH2-AU-PRE
			XLR 3 pole female, Horizontal PCB, Latching Type, Gold Plated Contacts, Bulk Pack Pin 1 to Chassis	Nickel Finish	AC3FBH3-AU-PRE
			XLR 3 pole female, Horizontal PCB, Non-Latching Type Gold Plated Contacts, Bulk Pack No Ground Link	Nickel Finish	AC3FBHL-AU-PRE

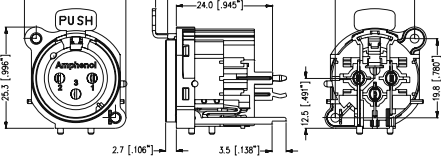

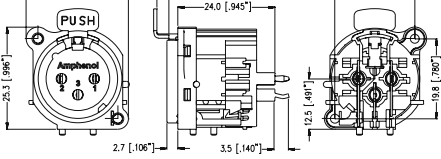

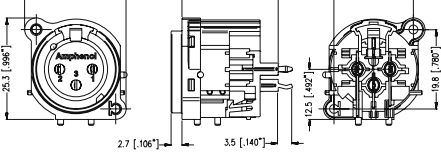





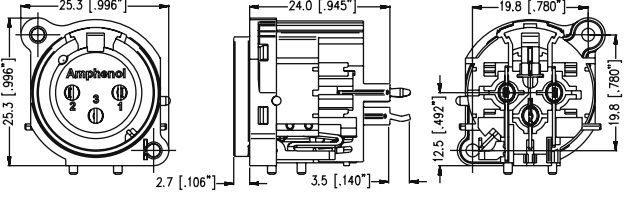

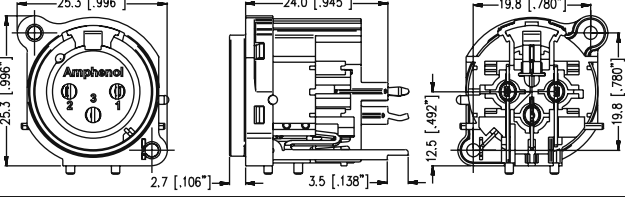
XLR Connectors

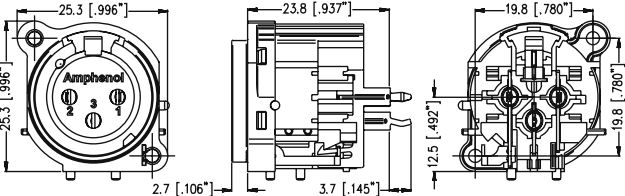
AC Series XLR PCB Chassis Mount Connectors

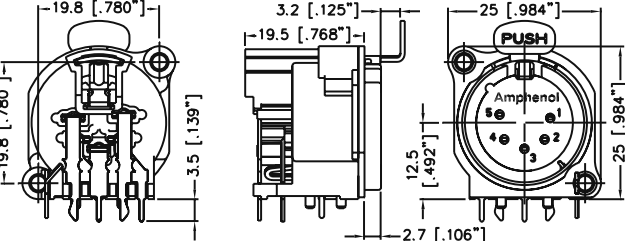
PRODUCT	DRAWING Dimensions in mm (inches)	DESCRIPTION/ GROUND LINK	FINISH	PART NUMBER
		XLR 3 pole female, Horizontal PCB, Non-Latching Type Gold Plated Contacts, Bulk Pack Pin 1 to Chassis to mating connector shell	Nickel Finish	AC3FBHL1-AU-PRE
		XLR 3 pole female, Horizontal PCB, Non- Latching Type, Gold Plated Contacts, Bulk Pack Mating connector shell to Chassis - Pin 1 sep. Ground.	Nickel Finish	AC3FBHL2-AU-PRE
		XLR 3 pole female, Horizontal PCB, Non-Latching Type Gold Plated Contacts, Bulk Pack Pin 1 to Chassis	Nickel Finish	AC3FBHL3-AU-PRE
		XLR 3 pole female, Vertical PCB, Latching Type, Gold Plated Contacts, Bulk Pack No Ground Link	Nickel Finish	AC3FBV-AU-PRE
		XLR 3 pole female, Vertical PCB, Latching Type, Gold Plated Contacts, Bulk Pack Pin 1 to Chassis to mating connector shell	Nickel Finish	AC3FBV1-AU-PRE
		XLR 3 pole female, Vertical PCB, Latching Type, Gold Plated Contacts, Bulk Pack Mating connector shell to Chassis - Pin 1 sep. Ground.	Nickel Finish	AC3FBV2-AU-PRE
		XLR 3 pole female, Vertical PCB, Latching Type, Gold Plated Contacts, Bulk Pack Pin 1 to Chassis	Nickel Finish	AC3FBV3-AU-PRE
		XLR 3 pole female, Vertical PCB, Non-Latching Type, Gold Plated Contacts, Bulk Pack No Ground Link	Nickel Finish	AC3FBVL-AU-PRE

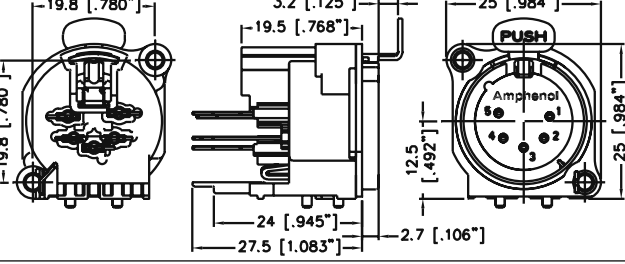
XLR Connectors

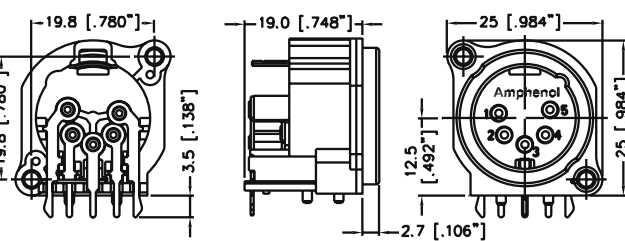
AC Series XLR PCB Chassis Mount Connectors

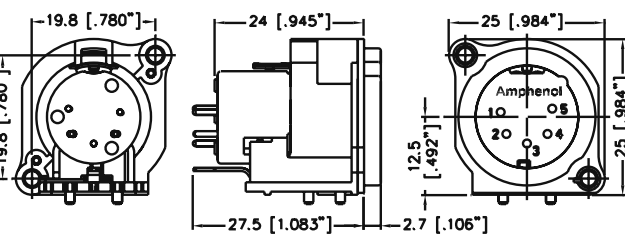
PRODUCT	DRAWING Dimensions in mm (inches)	DESCRIPTION/ GROUND LINK	FINISH	PART NUMBER
		XLR 3 pole female, Vertical PCB, Non-Latching Type, Gold Plated Contacts, Bulk Pack Pin 1 to Chassis to Mating connector shell	Nickel Finish	AC3FBVL1-AU-PRE
		XLR 3 pole female, Vertical PCB, Non-Latching Type, Gold Plated Contacts, Bulk Pack Mating connector shell to Chassis-Pin 1 sep. Ground.	Nickel Finish	AC3FBVL2-AU-PRE
		XLR 3 pole female, Vertical PCB, Non-Latching Type, Gold Plated Contacts, Bulk Pack Pin 1 to Chassis	Nickel Finish	AC3FBVL3-AU-PRE
		XLR 5 pole female, Horizontal PCB, Latching Type, Gold Plated Contacts, Bulk Pack	Nickel Finish	AC5FBH-AU-PRE
		XLR 5 pole female, Vertical PCB, Latching Type, Gold Plated Contacts, Bulk Pack	Nickel Finish	AC5FBV-AU-PRE
		XLR 5 pole male, Horizontal PCB, Gold Plated Contacts, Bulk Pack	Nickel Finish	AC5MBH-AU-PRE
		XLR 5 pole male, Vertical PCB, Gold Plated Contacts, Bulk Pack	Nickel Finish	AC5MBV-AU-PRE

XLR Connectors

AC Series XLR PCB Chassis Mount Connectors

PART NUMBER BREAKDOWN

AC SERIES A AND B TYPE MALE - 3 CONTACT

E. G. **AC3MAVL3-AU PRE**
AC (series prefix), **3** contacts, **M**ale, **A** Type, **V**ertical Printed Circuit Board, **L**atchless, **3** (Mating Shell to Pin 1 Grounding), **- AU** (Gold Plated Contacts), **PRE** Bulk Packaged.

SERIES PREFIX	AC = Series Prefix
CONTACT LAYOUT	3 = 3 Contact only
GENDER	M = Male Socket Contacts
SHELL SERIES	A = A Type B = B Type
TERMINATION	H = Horizontal Printed Circuit Board V = Vertical Printed Circuit Board Blank = Solder Bucket Contacts
MOUNTING FLANGE FINISH (B TYPE ONLY)	Blank = Nickel
LOCKING MECHANISM	Blank = Latching L = Latchless
GROUNDING LINK OPTIONS	Blank = No Ground Link 1 = Pin 1 to Chassis to mating connector shell 2 = Mating Connector shell to Chassis, Pin 1 to separate ground 3 = Mating connector to Pin 1 4 = Mating connector to Shell to Chassis to PCB, Pin 1 separate ground
CONTACT PLATING	AU = Gold Plated Contacts AG = Silver Plated Contacts (Non-Standard)
PACKAGING	PRE = Bulk Packed PRD = Disassembled push latch

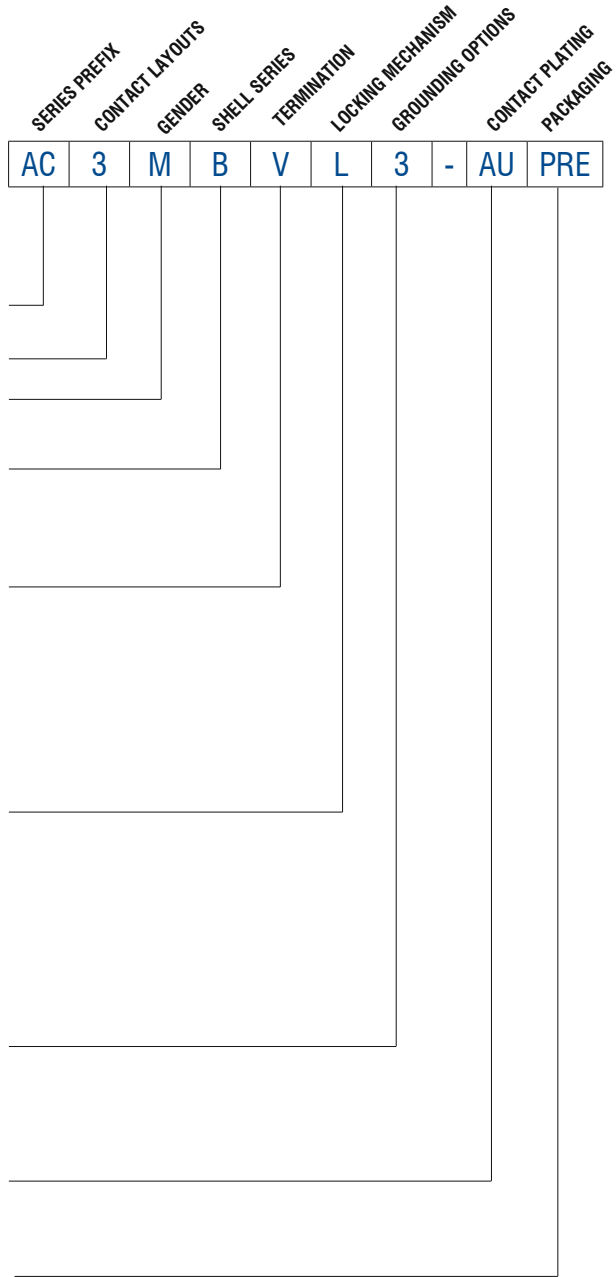

PART NUMBER BREAKDOWN

AC SERIES A AND B TYPE FEMALE - 3 CONTACT

E. G. **AC3MAVL3-AU B**
AC (series prefix), **3** contacts, **F**emale, **A** Type, **V**ertical Printed Circuit Board, **L**atchless, **3** (Pin 1 to Chassis Grounding), **- AU** (Gold Plated Contacts), **PRE** Bulk Packaged.

SERIES PREFIX	AC = Series Prefix
CONTACT LAYOUT	3 = 3 Contact only
GENDER	F = Female Socket Contacts
SHELL SERIES	A = A Type B = B Type
TERMINATION	H = Horizontal Printed Circuit Board V = Vertical Printed Circuit Board
LOCKING MECHANISM	Blank = Latching L = Latchless
GROUNDING LINK OPTIONS	Blank = No Ground Link 1 = Pin 1 to Chassis to mating connector shell 2 = Mating Connector shell to Chassis, Pin 1 to separate ground 3 = Pin 1 to Chassis
CONTACT PLATING	AU = Gold Plated Contacts AG = Silver Plated Contacts (Non-Standard)
PACKAGING	PRE = Bulk Packed PRD = Disassembled push latch

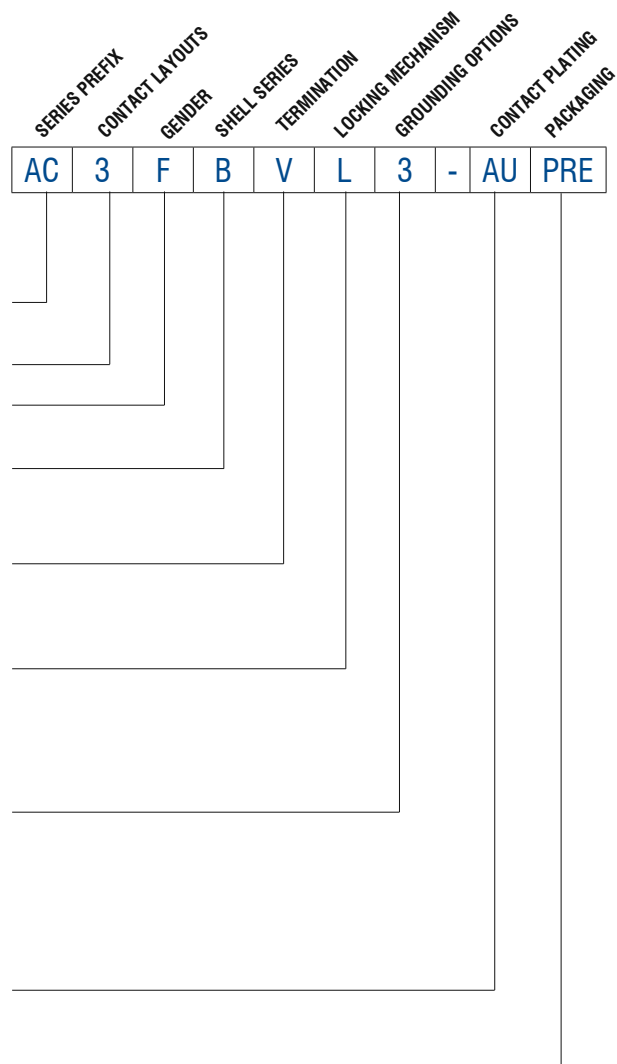

XLR Connectors

AC Series XLR PCB Chassis Mount Connectors

PART NUMBER BREAKDOWN



AC SERIES A AND B TYPE MALE AND FEMALE - 4 / 5 CONTACT

E. G. **AC5FAV-AU-B**
AC (series prefix), **5** contacts, **F**emale, **A** Type, **V**ertical Printed Circuit Board, **AU**
 (Gold Plated Contacts) - **B**ulk Packaged.

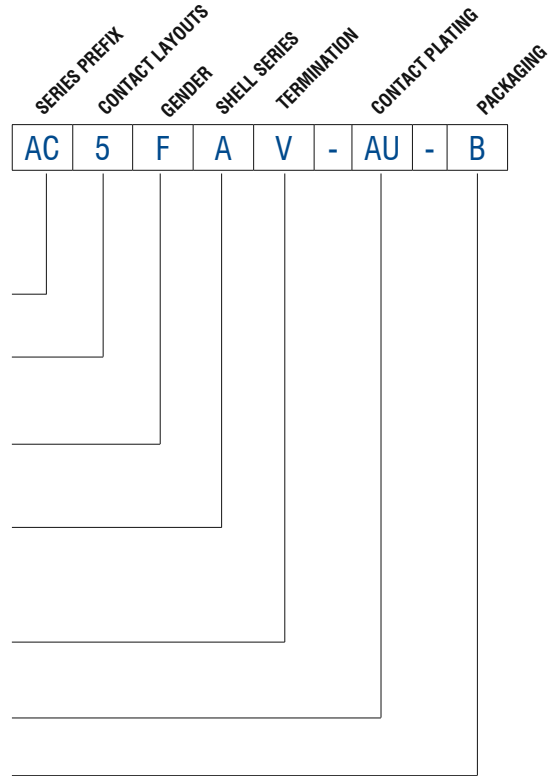
SERIES PREFIX	AC = Series Prefix
CONTACT LAYOUT	4 = 4 Contact 5 = 5 Contact
GENDER	F = Female Socket Contacts M = Male Pin Contacts
SHELL SERIES	A = A Type B = B Type
TERMINATION	H = Horizontal Printed Circuit Board V = Vertical Printed Circuit Board
CONTACT PLATING	AU = Gold Plated Contacts
PACKAGING	B = Bulk Packed PRE = PRE Series Bulk Packed



STANDARD DATA AC SERIES A AND B TYPE CHASSIS

		VALUE		
GENERAL CHARACTERISTICS	Number of contacts	3	4	5
	Contact Arrangements (Front view of pin insert)			
	Termination	Printed Circuit Board (PCB)		
	Flammability rating of plastics	UL94V-0		
	Environmental	Complies with EU RoHS 2 Directive 2011/65/EU		
ELECTRICAL CHARACTERISTICS	Service Voltage RMS	133V ¹		
	Test Voltage AC RMS	1500V		
	Current carrying capacity	6A	3A	
	Typical Contact Resistance	≤5mΩ		
	Insulation Resistance (initial)	≥2GΩ		
	Insulation Resistance (after damp heat test)	≥1GΩ		
CLIMATIC CHARACTERISTICS	Protection Class	IP40		
	Operating Temperature	-25°C to +75°C (-13°F to +167°F)		
MECHANICAL CHARACTERISTICS	Weight ²	14g (0.030lb)		
	Retention Spring separating force	≥20N		
	Mounting Screw torque max.	1.5Nm		
	Mechanical Operations	1500 mating cycles		
	Fastening A Type Connectors ³	Self-Tapping PT screw with thread 2.9 x 1.06 and of Tri-rondular configuration		
	Fastening B Type Connectors ³	Self-Tapping screw M2.5		
MATERIALS	Connector Flange - B-Type	Diecast Zinc Alloy		
	Flange Finish - B-Type	Nickel		
	Insulators	PA6.6+25% glass fibre reinforced, UL94V-0		
	Male Contact Material	Brass		
	Male Contact Plating	0.05μm gold over 2μm nickel		
	Female Contact Material	Bronze		
	Female Contact Plating	0.05μm gold over 2μm nickel		
	Latch lock and Spring	Spring Steel		
	Ground element	Spring Steel		

¹ Not suitable for domestic applications above 50V

² Approximate weight only, does not include packaging. Please contact us for exact weight for shipping purposes.

³ Refer to page 134

XLR Connectors

AC Series XLR PCB Chassis Mount Connectors

AC SERIES A AND B TYPE CHASSIS PCB FOOTPRINTS - CONNECTOR SIDE OF PCB

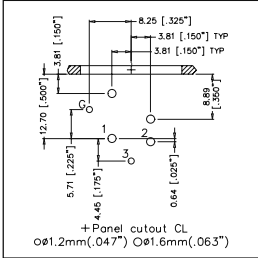

**AC3FAH2
AC3FBH2**

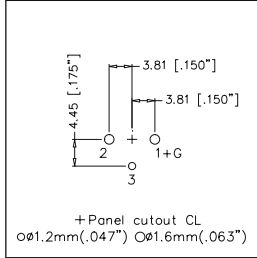

**AC3FAV1
AC3FAV3
AC3FBV1
AC3FBV3
AC3FAV
AC3FBV**

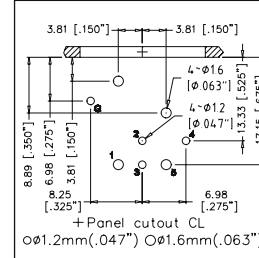

AC5FAH

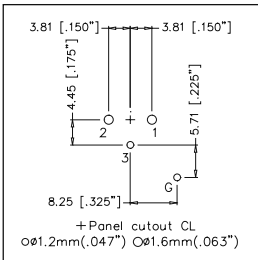

**AC3FAV2
AC3FBV2**

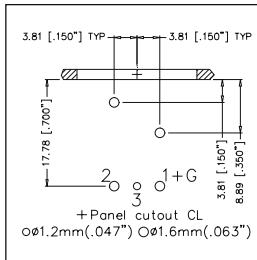

**AC3MAH1
AC3MAH3
AC3MBH1
AC3MBH3
AC3MAH
AC3MBH
AC3MBHL**

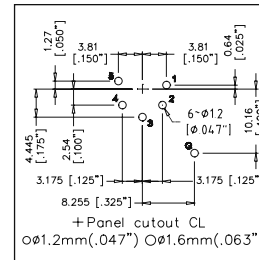

AC5FAV

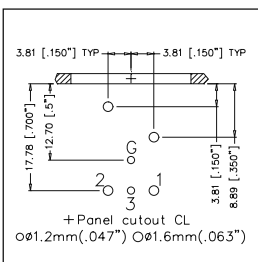

**AC3MAH2
AC3MAH4
AC3MBH2**

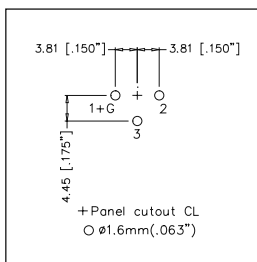

**AC3MAV1
AC3MAV3
AC3MBV1
AC3MBV3
AC3MAV
AC3MBV**

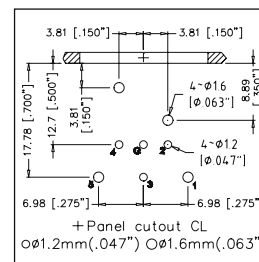

AC5MAH

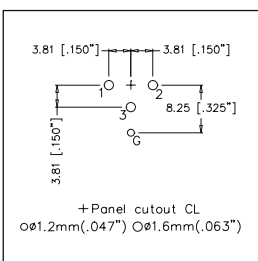

**AC3MAV2
AC3MAV4
AC3MBV2**

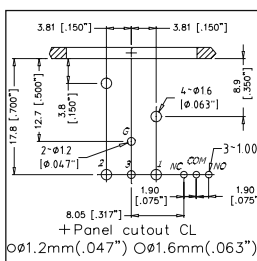

AC3MAH4SWB

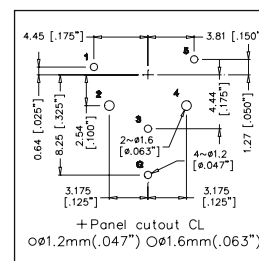

AC5MAV

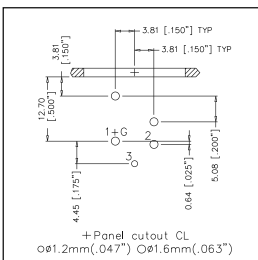

**AC3FAH1
AC3FAH3
AC3FBH1
AC3FBH3
AC3FAH
AC3FBH**

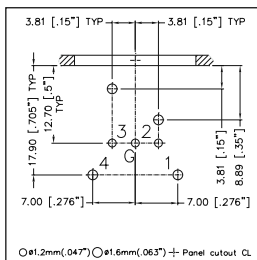

AC4MAH

AC SERIES A AND B TYPE CHASSIS PANEL CUTOUT DIMENSIONS - FRONT VIEW

A TYPE

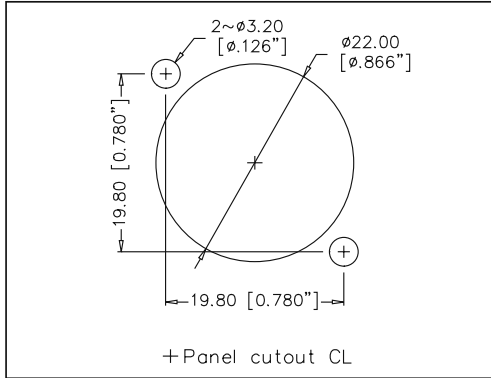

B TYPE

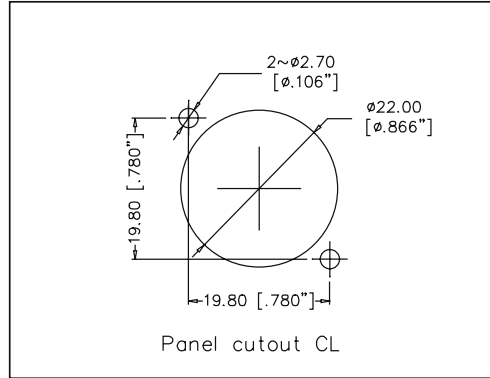

**A AND B
TYPE MALE
MOUNTING
PITCH**

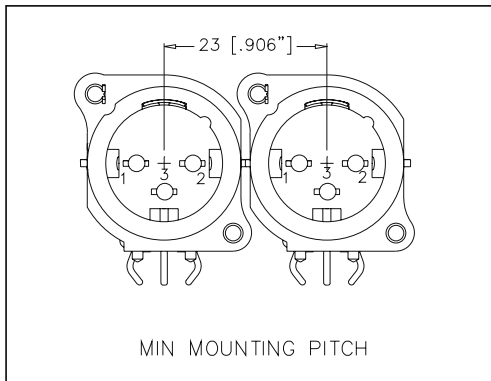

**A AND
B TYPE
FEMALE
MOUNTING
PITCH**

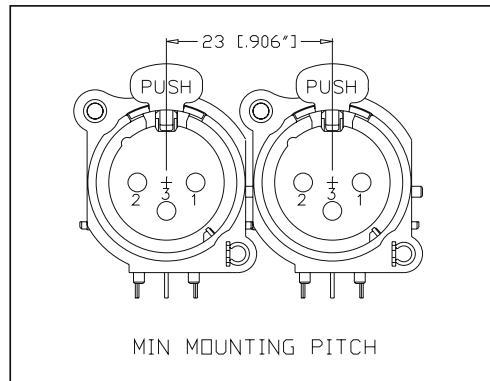

AC3FA/BH/V SCHEMATIC CHART

AC3FA/BH/V3-AU
AC3FA/BH/VL3-AU

AC3FA/BH/V2-AU
AC3FA/BH/VL2-AU

AC3FA/BH/V1-AU
AC3FA/BH/VL1-AU

AC3FA/BH/V-AU
AC3FA/BH/VL-AU

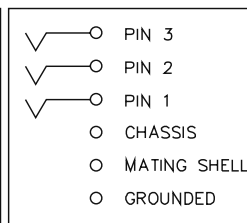
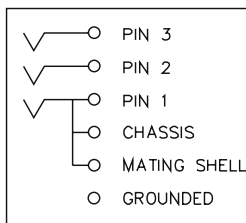
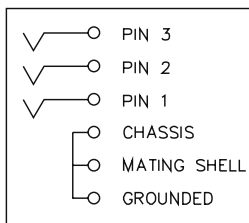
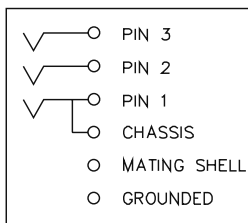

AC3MA/BH/V3-AU
AC3MA/BH/VL3-AU

AC3MA/BH/V2/4-AU
AC3MA/BH/VL2/4-AU

AC3MA/BH/V1-AU
AC3MA/BH/VL1-AU

AC3MA/BH/V-AU
AC3MA/BH/VL-AU

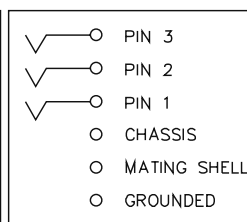
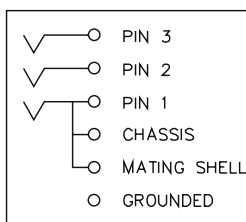
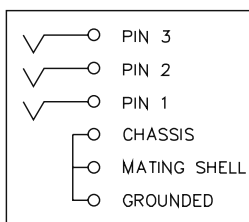
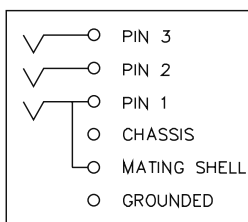

XLR Connectors

AC Series Dual 1/4" (6.35mm) / XLR Chassis Mount



AC SERIES DUAL 1/4" (6.35MM) / XLR CHASSIS MOUNT

The AC Series C type chassis receptacles feature two connectors in the one space saving housing. A combined XLR female receptacle together with a 6.35mm (1/4") phone jack give the designer more flexibility ensuring premium board space is saved. The new low profile high density C type offers a 15% space saving over the traditional C type. Various configurations are available in either stereo or mono layouts with Vertical, Horizontal Printed Circuit Board or Solder contacts.

Ordering Codes

We have listed the more common ordering codes in each section. For further options please refer to the part number breakdown charts. Please contact us if you need any further assistance.

Simple steps to guide you in using this catalogue

- 1) Identify the product group listed in Contents on page 1 and go directly to that page number.
- 2) Each product group cover page then details information and options available.
- 3) Refer to the product detail pages and identify the product you require pictorially.
- 4) Read the product description column for the products standard features.
- 5) Use variations column to determine your choice.
- 6) Identify part number.
- 7) In the event the particular option you require is not listed please refer to the part number breakdown page at the end of each section.
- 8) Please contact us directly if you have any further problems.

Features

- Standard or low profile / high density shell design
- Two connectors in the one housing.
- Industry standard PCB footprint layout on standard C type.
- Vertical or Horizontal PCB mounting.
- Bulk packed.
- Positive latch lock system (XLR).

Options

- Solder contacts
- Vertical PCB contacts
- Horizontal PCB contacts
- Bulk Packaging
- Overmoldable connector housing

XLR Connectors

AC Series Dual 1/4" (6.35mm) / XLR Chassis Mount



Features:

- Two connectors in the one housing.
- Low profile design offers a 15% space saving over the traditional design.
- Vertical or Horizontal PCB mounting.
- Bulk packed in trays, 100 to a box as standard.
- Positive latch lock system (XLR).

Part Number Breakdown: [Page 48](#)

Specifications: [Page 50](#)

PCB Footprints: [Page 49](#)

Recommended Fastener: [Page 134](#)

PRODUCT - FIGURE	DRAWING	Dimensions in mm (inches)	DESCRIPTION	VARIATIONS	PART NUMBER
		19.80 781 25.30 996 25.30 996 19.80 781 27.5 1082 2.7 106 3.5 138	Low Profile XLR 3 pole female receptacle with 1/4" stereo jack without switching contact, Horizontal PCB mount, Bulk Pack	Latching	ACJC6AH BULK
		19.80 781 25.30 996 25.30 996 19.80 781 27.5 1082 2.7 106 3.5 138	Low Profile XLR 3 pole female receptacle with 1/4" stereo jack without switching contact, Horizontal PCB mount, Bulk Pack	Non-latching, Retention Spring	ACJC6AHL BULK
		19.80 781 25.3 996 25.3 996 19.80 781 24.0 945 6.2 165 3.7 146	Low Profile XLR 3 pole female receptacle with 1/4" stereo jack without switching contact, Vertical PCB mount, Bulk Pack	Latching	ACJC6AV2 BULK
		19.80 781 25.3 996 25.3 996 19.80 781 24.0 945 6.2 165 3.7 146	Low Profile XLR 3 pole female receptacle with 1/4" stereo jack without switching contact, Vertical PCB mount, Bulk Pack	Non-latching, Retention Spring	ACJC6AV2L BULK
		19.80 781 25.30 996 25.30 996 19.80 781 27.5 1082 2.7 106 3.50 138	Low Profile XLR 3 pole female receptacle with 1/4" switching stereo jack, Horizontal PCB mount, Bulk Pack	Latching	ACJC9AH BULK
		19.80 781 25.30 996 25.30 996 19.80 781 27.5 1082 2.7 106 3.50 138	Low Profile XLR 3 pole female receptacle with 1/4" switching stereo jack, Horizontal PCB mount, Bulk Pack	Non-latching, Retention Spring	ACJC9AHL BULK

XLR Connectors

AC Series Dual 1/4" (6.35mm) / XLR Chassis Mount

PRODUCT - FIGURE	DRAWING	Dimensions in mm (inches)	DESCRIPTION	VARIATIONS	PART NUMBER
			Low Profile XLR 3 pole female receptacle with 1/4" switching stereo jack, Vertical PCB mount, Bulk Pack	Latching	ACJC9AV2 BULK
			Low Profile XLR 3 pole female receptacle with 1/4" switching stereo jack, Vertical PCB mount, Bulk Pack	Non-latching, Retention Spring	ACJC9AV2L BULK
			Low Profile XLR 3 pole female receptacle with 1/4" switching stereo jack and switching ground contact, Horizontal PCB mount, Bulk Pack	Latching	ACJC10AH BULK
			Low Profile XLR 3 pole female receptacle with 1/4" switching stereo jack and switching ground contact, Horizontal PCB mount, Bulk Pack	Non-latching, Retention Spring	ACJC10AHL BULK
			Low Profile XLR 3 pole female receptacle with 1/4" switching stereo jack and switching ground contact, Vertical PCB mount, Bulk Pack	Latching	ACJC10AV2 BULK
			Low Profile XLR 3 pole female receptacle with 1/4" switching stereo jack and switching ground contact, Vertical PCB mount, Bulk Pack	Non-latching, Retention Spring	ACJC10AV2L BULK

XLR Connectors

AC Series Dual 1/4" (6.35mm) / XLR Chassis Mount

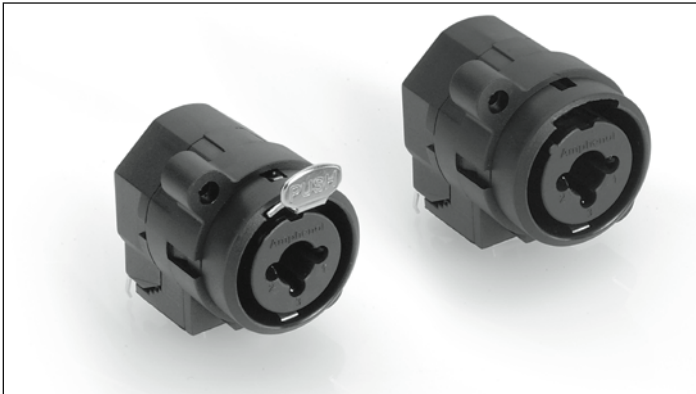

Features:

- Two connectors in the one housing.
- Space saving design.
- Industry standard PCB footprint layout.
- Vertical or Horizontal PCB mounting.
- Bulk packed in trays, 100 to a box as standard.
- Positive latch lock system (XLR).

Part Number Breakdown: Page 48

Specifications: Page 50











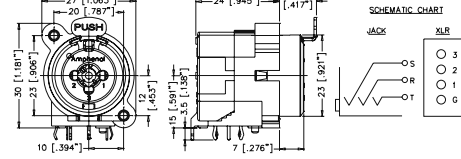

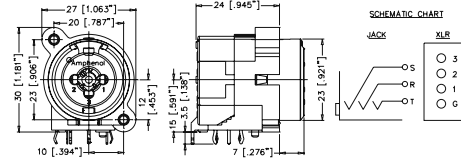

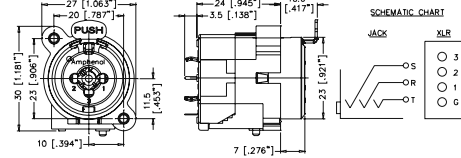
PCB Footprints: Page 49

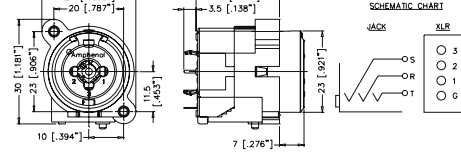
Recommended Fastener: Page 134

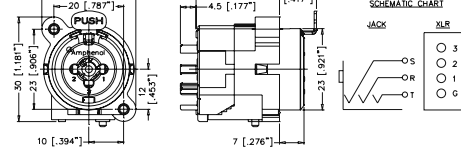
PRODUCT - FIGURE	DRAWING	Dimensions in mm (inches)	DESCRIPTION	VARIATIONS	PART NUMBER
		27 [1.063"] 20 [0.787"] 30 [1.181"] 23 [0.906"] 10 [.394"] 12 [.475"] 24 [.945"] 10.6 [.417"] 23 [.921"] 7 [.276"] 15 [.591"] 3.5 [0.138"]	XLR 3 pole female receptacle with 1/4" mono jack without switching contact, Horizontal PCB mount, Bulk Pack	Latching	ACJC5H BULK
		27 [1.063"] 20 [0.787"] 30 [1.181"] 23 [0.906"] 10 [.394"] 12 [.475"] 24 [.945"] 10.6 [.417"] 23 [.921"] 7 [.276"] 15 [.591"] 3.5 [0.138"]	XLR 3 pole female receptacle with 1/4" mono jack without switching contact, Horizontal PCB mount, Bulk Pack	Non-latching, Retention Spring	ACJC5HL BULK
		27 [1.063"] 20 [0.787"] 30 [1.181"] 23 [0.906"] 10 [.394"] 12 [.475"] 24 [.945"] 10.6 [.417"] 23 [.921"] 7 [.276"] 15 [.591"] 3.5 [0.138"]	XLR 3 pole female receptacle with 1/4" mono jack without switching contact, Vertical PCB mount, Bulk Pack	Latching	ACJC5V BULK
		27 [1.063"] 20 [0.787"] 30 [1.181"] 23 [0.906"] 10 [.394"] 11.5 [.453"] 24 [.945"] 3.5 [0.138"] 23 [.921"] 7 [.276"]	XLR 3 pole female receptacle with 1/4" mono jack without switching contact, Vertical PCB mount, Bulk Pack	Non-latching, Retention Spring	ACJC5VL BULK
		27 [1.063"] 20 [0.787"] 30 [1.181"] 23 [0.906"] 10 [.394"] 12 [.475"] 24 [.945"] 10.6 [.417"] 23 [.921"] 7 [.276"] 15 [.591"] 4.5 [0.177"]	XLR 3 pole female receptacle with 1/4" mono jack without switching contact, Solder Contacts, Bulk Pack	Latching	ACJC5S BULK
		27 [1.063"] 20 [0.787"] 30 [1.181"] 23 [0.906"] 10 [.394"] 12 [.475"] 24 [.945"] 10.6 [.417"] 23 [.921"] 7 [.276"] 15 [.591"] 4.5 [0.177"]	XLR 3 pole female receptacle with 1/4" mono jack without switching contact, Solder Contacts, Bulk Pack	Non-latching, Retention Spring	ACJC5SL BULK

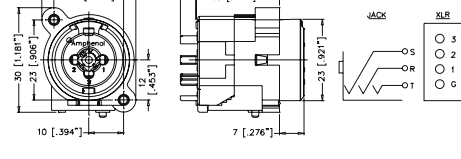

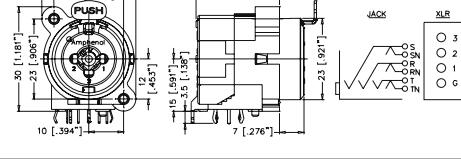

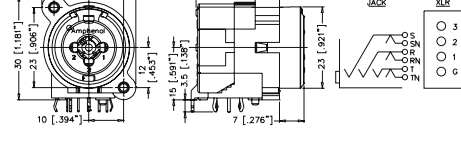





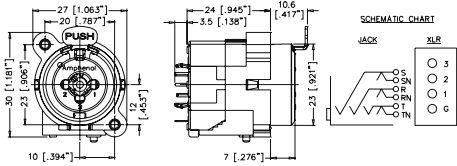

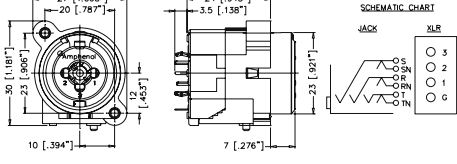

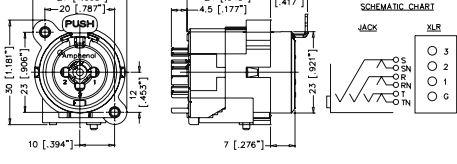
XLR Connectors

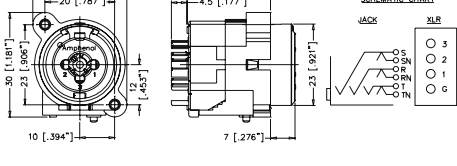
AC Series Dual 1/4" (6.35mm) / XLR Chassis Mount

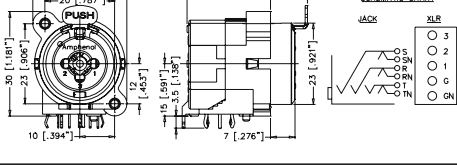
PRODUCT - FIGURE	DRAWING	DESCRIPTION	VARIATIONS	PART NUMBER
		XLR 3 pole female receptacle with 1/4" stereo jack without switching contact, Horizontal PCB mount, Bulk Pack	Latching	ACJC6H BULK
		XLR 3 pole female receptacle with 1/4" stereo jack without switching contact, Horizontal PCB mount, Bulk Pack	Non-latching, Retention Spring	ACJC6HL BULK
		XLR 3 pole female receptacle with 1/4" stereo jack without switching contact, Vertical PCB mount, Bulk Pack	Latching	ACJC6V BULK
		XLR 3 pole female receptacle with 1/4" stereo jack without switching contact, Vertical PCB mount, Bulk Pack	Non-latching, Retention Spring	ACJC6VL BULK
		XLR 3 pole female receptacle with 1/4" stereo jack without switching contact, Solder Contacts, Bulk Pack	Latching	ACJC6S BULK
		XLR 3 pole female receptacle with 1/4" stereo jack without switching contact, Solder Contacts, Bulk Pack	Non-latching, Retention Spring	ACJC6SL BULK
		XLR 3 pole female receptacle with 1/4" switching stereo jack, Horizontal PCB mount, Bulk Pack	Latching	ACJC9H BULK
		XLR 3 pole female receptacle with 1/4" switching stereo jack, Horizontal PCB mount, Bulk Pack	Non-latching, Retention Spring	ACJC9HL BULK

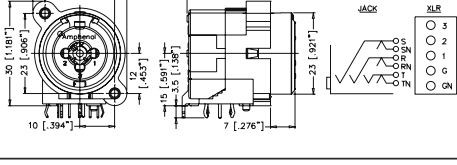

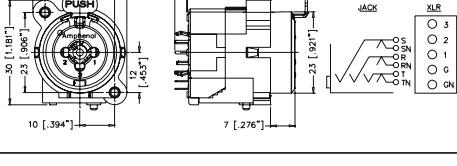
XLR Connectors

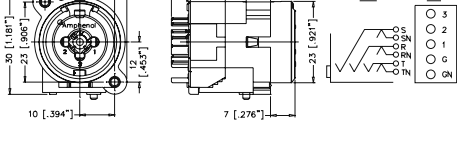
AC Series Dual 1/4" (6.35mm) / XLR Chassis Mount

PRODUCT - FIGURE	DRAWING	DESCRIPTION	VARIATIONS	PART NUMBER
		XLR 3 pole female receptacle with 1/4" switching stereo jack, Vertical PCB mount, Bulk Pack	Latching	ACJC9V BULK
		XLR 3 pole female receptacle with 1/4" switching stereo jack, Vertical PCB mount, Bulk Pack	Non-latching, Retention Spring	ACJC9VL BULK
		XLR 3 pole female receptacle with 1/4" switching stereo jack, Solder Contacts, Bulk Pack	Latching	ACJC9S BULK
		XLR 3 pole female receptacle with 1/4" switching stereo jack, Solder Contacts, Bulk Pack	Non-latching, Retention Spring	ACJC9SL BULK
		XLR 3 pole female receptacle with 1/4" switching stereo jack and switching ground contact, Horizontal PCB mount, Bulk Pack	Latching	ACJC10H BULK
		XLR 3 pole female receptacle with 1/4" switching stereo jack and switching ground contact, Horizontal PCB mount, Bulk Pack	Non-latching, Retention Spring	ACJC10HL BULK
		XLR 3 pole female receptacle with 1/4" switching stereo jack and switching ground contact, Vertical PCB mount, Bulk Pack	Latching	ACJC10V BULK
		XLR 3 pole female receptacle with 1/4" switching stereo jack and switching ground contact, Vertical PCB mount, Bulk Pack	Non-latching, Retention Spring	ACJC10VL BULK

XLR Connectors

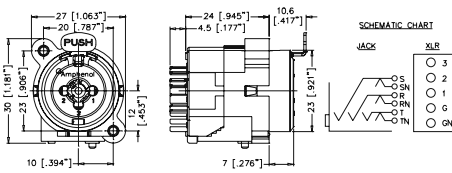
AC Series Dual 1/4" (6.35mm) / XLR Chassis Mount

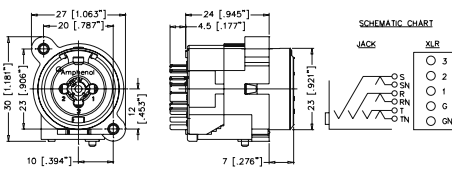
PRODUCT - FIGURE	DRAWING	DESCRIPTION	VARIATIONS	PART NUMBER
		XLR 3 pole female receptacle with 1/4" switching stereo jack and switching ground contact, Solder Contacts, Bulk Pack	Latching	ACJC10S BULK
		XLR 3 pole female receptacle with 1/4" switching stereo jack and switching ground contact, Solder Contacts, Bulk Pack	Non-latching, Retention Spring	ACJC10SL BULK

PART NUMBER BREAKDOWN

AC SERIES THERMOPLASTIC C TYPE

E. G. **ACJC5HL BULK**
AC (Series Prefix), **JC** Jack/Connector XLR, **5** Mono, **H**orizontal Printed Circuit Board, **L**atchless, **BULK** Packaged.

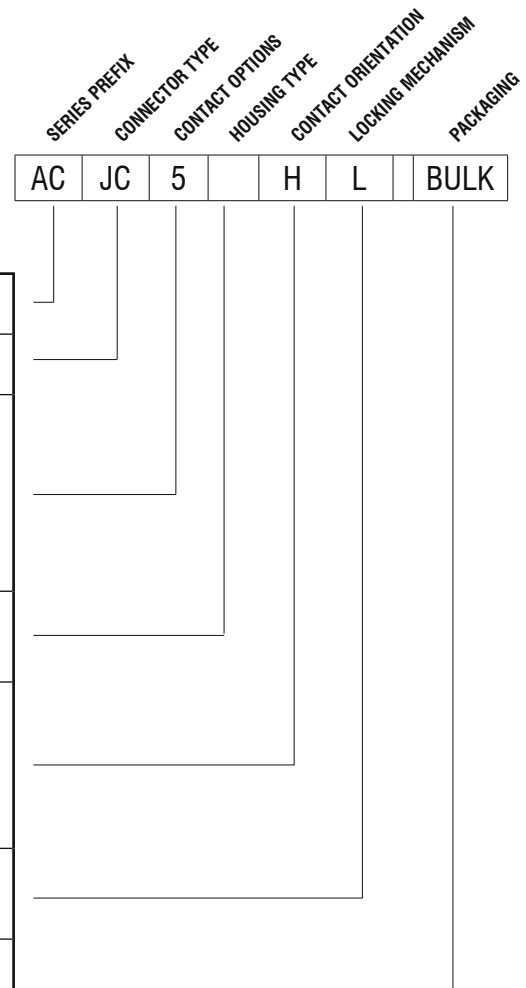

SERIES PREFIX	AC = Series Prefix
CONNECTOR TYPE	JC = Jack / Connector XLR
CONTACT OPTIONS	5 = Mono, Non Switching, XLR Grounded 6 = Stereo, Non Switching, XLR Grounded 9 = Stereo, Switching, XLR Grounded 10 = Stereo, Switching, XLR with Ground Switch
HOUSING TYPE	Blank = Standard A = Low Profile / High Density
CONTACT TYPE	V = Vertical Printed Circuit Board V2 = Vertical Printed Circuit Board (24mm) H = Horizontal Printed Circuit Board S = Solder Contacts
LOCKING MECHANISM	Blank = Latching L = Latchless
PACKAGING	Blank = Individual Bags BULK = Bulk Packed PRD = Disassembled push lever

AC SERIES C TYPE SERIES

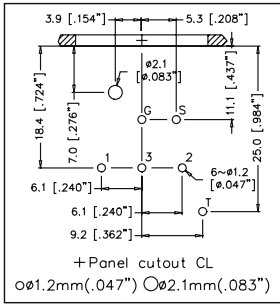

ACJC5H & ACJC5HL

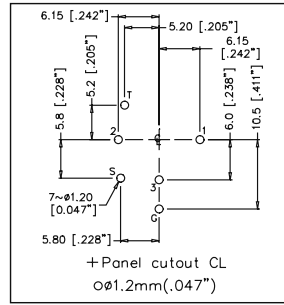

ACJC5V & ACJC5VL

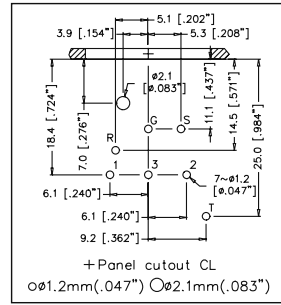

ACJC6H & ACJC6HL

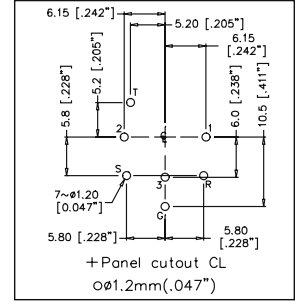

ACJC6V & ACJC6VL

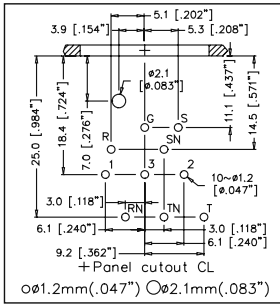

ACJC9H & ACJC9HL

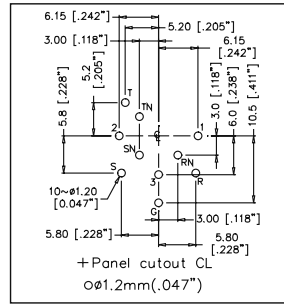

ACJC9V & ACJC9VL

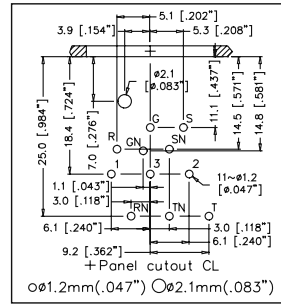

ACJC10H & ACJC10HL

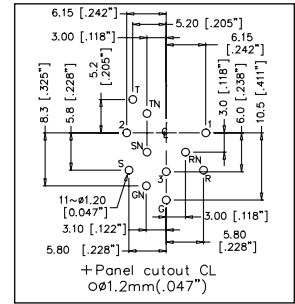

ACJC10V & ACJC10VL

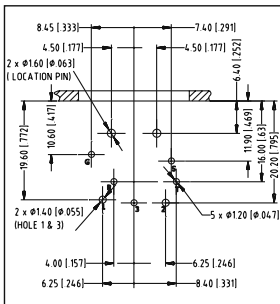

ACJC6AH & ACJC6AHL

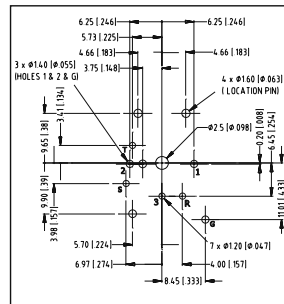

ACJC6AV2 & ACJC6AV2L

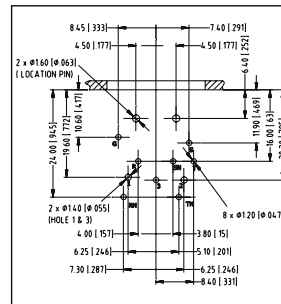

ACJC9AH & ACJC9AHL

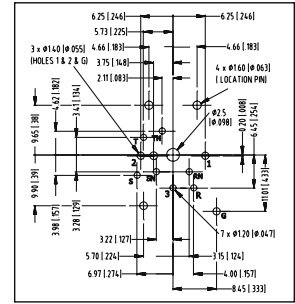

ACJC9AV2 & ACJC9AV2L

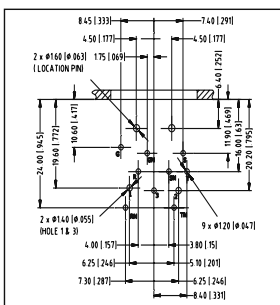

ACJC10AH & ACJC10AHL

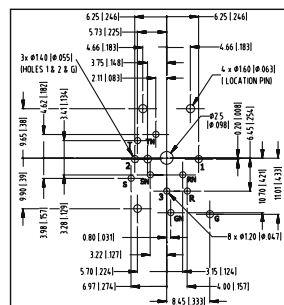

ACJC10AV2 & ACJC10AV2L

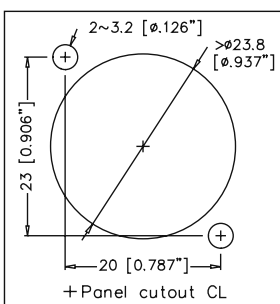

C TYPE PANEL CUTOUT

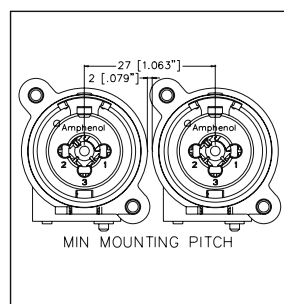

C TYPE MOUNTING PITCH

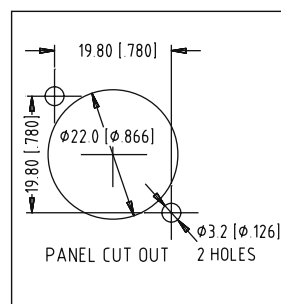

C TYPE LOW PROFILE PANEL CUTOUT

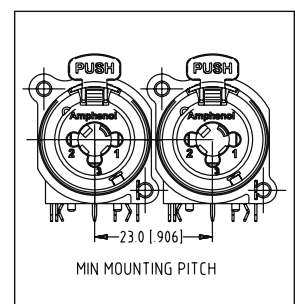

C TYPE LOW PROFILE MOUNTING PITCH

XLR Connectors

AC Series Dual 1/4" (6.35mm) / XLR Chassis Mount

STANDARD DATA C TYPE CHASSIS RECEPTACLES

		VALUE	
		LOW PROFILE TYPE	STANDARD C TYPE
GENERAL CHARACTERISTICS	Number of contacts	5, 6, 9 or 10	
	Termination	Printed Circuit Board (PCB)	Printed Circuit Board (PCB) or Solder Bucket
	Flammability	UL 94HB	
	Environmental	Complies with EU RoHS 2 Directive 2011/65/EU	
ELECTRICAL CHARACTERISTICS	Service Voltage RMS	50V	
	Test Voltage AC RMS	1500V	
	Current carrying capacity	7.5A	
	Typical Contact Resistance	≤50mΩ	
	Insulation Resistance (initial)	> 0.5GΩ	
	Insulation Resistance (after damp heat test)	> 0.2GΩ	
CLIMATIC CHARACTERISTICS	Protection Class	IP40	
	Operating Temperature	-25 °C to +70 °C	
MECHANICAL CHARACTERISTICS	Weight**	9.2g (0.02lb)	14g (0.030lb)
	Retention Spring separating force	≥20N	
	Mounting Screw torque max.	1.5Nm	
	Mechanical Operations	1500 mating cycles	
	Fastening***	Self-Tapping PT screw with thread 2.9 x 1.06 and of Tri-rondular configuration	
MATERIALS	Connector Shell	PA6.6 + 30% glass fibre reinforced, UL94HB	PA6.6 + 20% glass fibre reinforced, UL94HB
	Shell Finish		Black
	Insulators	PA6.6 glass fibre reinforced, UL94HB	PA6.6 + 20% glass fibre reinforced, UL94HB
	XLR Contact		
	Material	Bronze	
	Plating	Gold over Nickel plated	
	Jack Contact		
	Material	Bronze	Brass
Plating	Gold over Nickel plated	Silver over Copper plated	
Latch lock and Spring	Nickel Plated		
Ground element	Nickel Plated	Silver over Copper plated	

**Approximate weight in grams not including packaging. Please contact us for exact weight for shipping purposes.

***Refer to Page 134

Rev 6 - 03/2013



G-TYPE MINIATURE XLR CONNECTORS

Features:

- Miniature version of the standard XLR series
- Diecast or Precision machined metal housings
- Metal cable clamp
- Precision machined pin contacts
- Stamped socket contacts
- Solder cup or Printed Circuit board contacts
- Available in 3, 4, 5 or 6 contacts
- Postive latchlock
- Flexible cable grommet



Part Number Breakdown: Page 52
PCB Footprints: Page 54

Specifications: Page 53
Panel Cutouts: Page 54

PRODUCT - FIGURE	DRAWING	DESCRIPTION	VARIATIONS	PART NUMBER
		Male cable connector, Machined contacts, Nickel Finish	3 pole 4 pole 5 pole 6 pole	AG3M AG4M AG5M AG6M
		Female cable connector, Stamped contacts, Nickel Finish	3 pole 4 pole 5 pole 6 pole	AG3F AG4F AG5F AG6F
		Female cable connector with locking ring, Stamped contacts, Nickel Finish.	3 pole 4 pole 5 pole 6 pole	AG3FL AG4FL AG5FL AG6FL
		Male chassis connector, Machined contacts, Nickel Finish	3 pole 4 pole 5 pole 6 pole	AG3MCC AG4MCC AG5MCC AG6MCC
		Female chassis connector, Stamped contacts, Nickel Finish	3 pole 4 pole 5 pole 6 pole	AG3FCE AG4FCE AG5FCE AG6FCE
		Male chassis connector, Horizontal PCB, Machined contacts, Nickel Finish	3 pole 4 pole 5 pole 6 pole	AG3MCCH AG4MCCH AG5MCCH AG6MCCH
		Female chassis connector, Horizontal PCB, Stamped contacts, Nickel Finish	3 pole 4 pole 5 pole 6 pole	AG3FCCH AG4FCCH AG5FCCH AG6FCCH

XLR Connectors

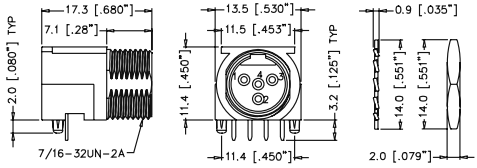
G-Type Miniature XLR Connectors

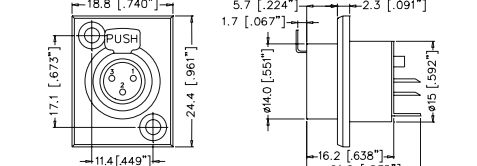
		<p>Male chassis connector, Horizontal PCB, Machined contacts, Thermoplastic shell</p>	<p>4 pole</p>	<p>AG4MPCH</p>
		<p>Female chassis connector, Stamped contacts, Nickel Finish</p>	<p>3 pole</p>	<p>AG3FCRV</p>
			<p>4 pole</p>	<p>AG4FCRV</p>
			<p>5 pole</p>	<p>AG5FCRV</p>
			<p>6 pole</p>	<p>AG6FCRV</p>

PART NUMBER BREAKDOWN

G TYPE CONNECTORS

E. G. **AG3MCCHB**
AG (Series Prefix), **3** contacts, **Male**, **Chassis Connector**, **Horizontal PCB Contacts**, **Black finish**.

SERIES PREFIX	AG	=	Series Prefix
CONTACT LAYOUTS	3	=	3 Contacts
	4	=	4 Contacts
	5	=	5 Contacts
	6	=	6 Contacts
GENDER	F	=	Female Socket Contacts
	M	=	Male Pin Contacts
	Blank	=	Cable Connector Standard (Male or Female)
SHELL STYLE	J	=	Cable Connector Large Cable clamp / boot O.D (Male or Female)
	L	=	Cable Connector with locking ring (Female)
	LL	=	Latchless (Chassis Connector)
	CC	=	Chassis Connector Circular Metal (Male)
	CE	=	Rear Mount (Chassis Connector)
	CM	=	Mid Mount (Chassis Connector)
	CR	=	Chassis Connector Rectangular Metal (Female)
	PC	=	Chassis Connector Plastic (Male)
	Blank	=	Solder Buckets (All styles except PC, CR)
CONTACT TYPE	H	=	Horizontal PCB (Style CC, PC only)
	V	=	Vertical PCB (Style CR only)
	Blank	=	Nickel Plated Finish
SHELL FINISH	B	=	Black Finish

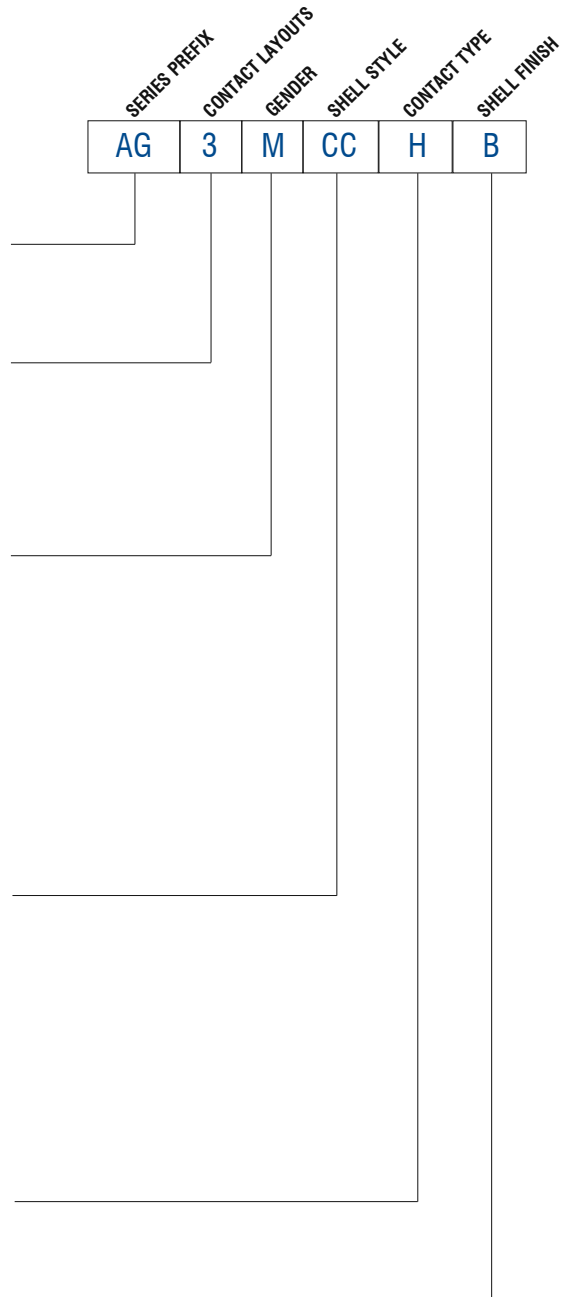

STANDARD DATA G TYPE

		VALUE			
GENERAL CHARACTERISTICS	Number of Contacts	3	4	5	6
	Termination	Printed Circuit Board (PCB) or Solder Bucket			
	Max. Wire Gauge - Stranded Wire	AWG 24 - 0.2mm ²			AWG 28 - 0.08mm ²
	Flammability	UL94V-HB			
	Environmental	Complies with EU RoHS 2 Directive 2011/65/EU			
ELECTRICAL CHARACTERISTICS	Current Carrying Capacity	5A	5A	4A	1.2A
	Typical Contact Resistance	≤10mΩ			
	Insulation resistance (initial) After Damp Heat Test	≥510MΩ ≥10MΩ			
	Dielectric Strength	1000 V dc			250 V dc
CLIMATIC CHARACTERISTICS	Protection Class	IP00			
	Operating Temperature	-30 °C to +80 °C (-20F - +176F)			
MECHANICAL CHARACTERISTICS	Insertion Spring Separating Force	≥20N			
	Cable O.D.	Standard	2mm to 3.5mm (0.078" to 0.137")		
		Large clamp / boot (Option "J")	3mm to 5mm (0.118" to 0.196")		
	Mechanical Operations	5000 mating cycles			2000 mating cycles
Weight	13.5g (0.029lb)				
MATERIALS	Connector Shell	Bronze & Zinc			
	Connector Shell Finish	Nickel Plated			
	Insulators	PPS - Black			
	Male Contact	Material - Brass C3604 Plating - Gold over Silver Plated			
	Female Contact	Material - Brass C5210P Plating - Gold over Silver Plated			
	Latch Lock and Spring	SUS (AISI - 301) - Nickel Plated			
	Adaptor	PPS - Black			
	Cable Clamp	Bronze - Nickel Plated			
	Boot/Backshell	ABS - Black			
	Grommet	PU - Black			

Rev 7 - 09/2023

¹⁾Approximate weight only, does not include packaging. Please contact us for exact weight for shipping purposes.
Not suitable for voltages over 50V.

XLR Connectors

G-Type Miniature XLR Connectors

PANEL CUTOUTS - CONNECTOR SIDE OF PCB

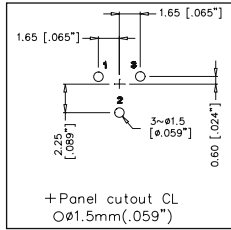

AG3MCC

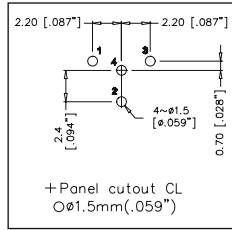

AG4MCC

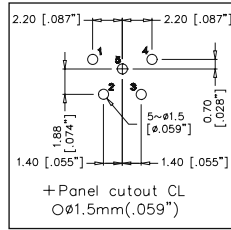

AG5MCC

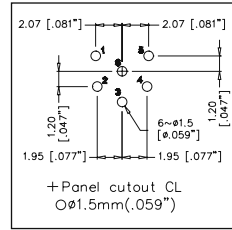

AG6MCC

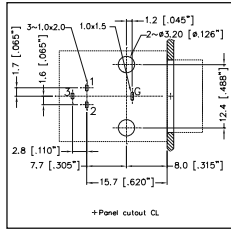

AG3FCCH

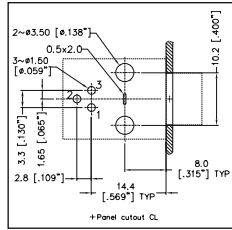

AG3MCCCH

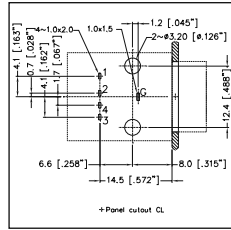

AG4FCCH

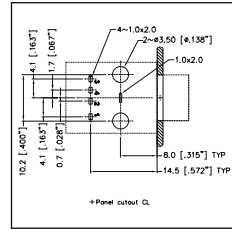

AG4MCCCH

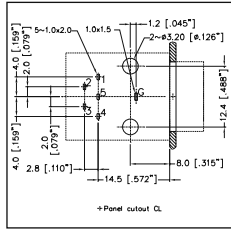

AG5FCCH

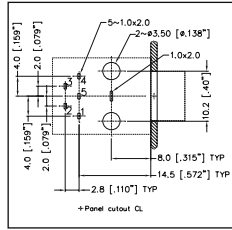

AG5MCCCH

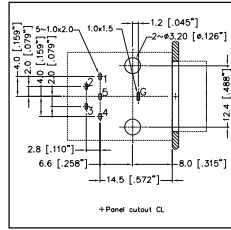

AG6FCCH

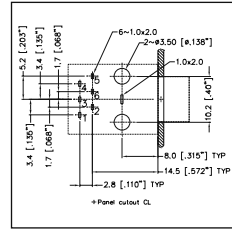

AG6MCCCH

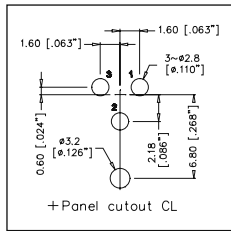

AG3FCRV

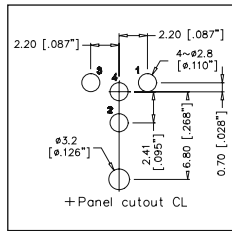

AG4FCRV

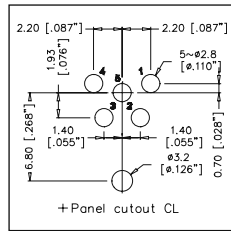

AG5FCRV

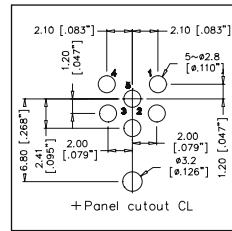

AG6FCRV

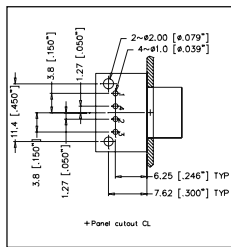

AG4MPCH

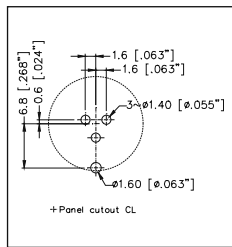

AG3FCE

PANEL CUTOUTS - FRONT VIEW

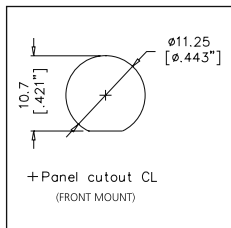

**AG3MCC
AG4MCC
AG5MCC
AG6MCC**

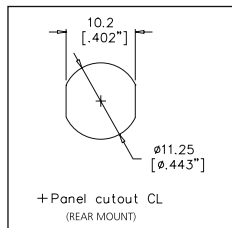

**AG3MCCCH
AG4MCCCH
AG5MCCCH
AG6MCCCH
AG4MPCH**

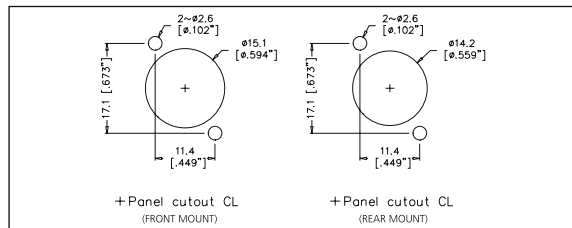

**AG3FCRV
AG4FCRV
AG5FCRV
AG6FCRV**



SP/EP/AP SERIES LOUDSPEAKER CONNECTORS

SP Series

The SP Series are available in 2 or 4 pole chassis mount connectors. The durable thermoplastic housings are fitted with high power contacts to ensure optimal current carrying capacity. Completely intermatable with industry standard loudspeaker connections.

Features

- High current contacts for distortion free signal.
- Cost effective durable thermoplastic shell
- Available in 2 and 4 contact arrangements.
- Overmolded cable support boot or PG gland with or without cable support strain relief.
- Quick release, vibration resistant latch lock.
- UL, cUL recognized components (File no. E339831)
- Precision machined contacts
- Thermoplastic shell

Options

- Solder termination / Tab or Printed Circuit Board versions, Screw Terminals
- Nickel Plated Zinc Alloy shell
- Black finished Zinc Alloy shell

EP Series

The EP Series incorporates a rugged zinc diecast shell to give it maximum durability when used in demanding situations. The EP cable connector cable flex relief design minimises cable bend stress at point of entry into the connector housing.

Features

- High current contacts for distortion free signal.
- Tough, durable zinc diecast shell
- Cable clamp capable of supporting cables from 9mm (0.35") to 16mm (0.63") in diameter.
- Quick release, vibration resistant latch lock.
- AP & EP series are completely intermatable.
- Precision machined contacts

Options

- Nickel Plated Zinc Alloy shell
- Black finished Zinc Alloy shell
- Available in 3, 4, 5, 6 and 8 contact arrangements

AP Series

The AP Series Shell is manufactured from tough, durable thermoplastic, and ideal for fixed indoor installations. Both the EP and AP Series utilise the same contact and insulator components.

Features

- High current contacts for distortion free signal.
- Cost effective durable thermoplastic shell
- Quick release, vibration resistant latch lock.
- AP & EP series are completely intermatable.
- Precision machined contacts
- Thermoplastic shell

Options

- Available in 4, 5, 6, and 8 contact arrangements.

Ordering Codes

We have listed the more common ordering codes in each section. Please contact us if you need any further assistance.

Simple steps to guide you in using this catalogue

- 1) Identify the product group listed in Contents on page 1 and go directly to that page number.
- 2) Each product group cover page then details information and options available.
- 3) Refer to the product detail pages and identify the product you require pictorially.
- 4) Read the product description column for the products standard features.
- 5) Use variations column to determine your choice.
- 6) Identify part number.
- 7) In the event the particular option you require is not listed please refer to the part number breakdown page at the end of each section.
- 8) Please contact us directly if you have any further problems.

Speaker Connectors

SP Series



SP SERIES

Amphenol's range of loudspeaker connectors have been further enhanced with the introduction of the SP Series. Designed to complement the popular EP/AP Series, we now offer a range of loudspeaker connectors to suit most applications. SP Series chassis connectors are available in industry standard PCB footprints with solder tabs. SP Series cable plugs are available with screw or solder terminals.

Features:

- Quick release, vibration resistant latch lock
- 2 or 4 pole
- Solder tabs, PCB Contacts, Solder or Screw Terminals
- Chuck type or PG Gland cable clamp
- Various mounting hole options
- 30A Current rating
- Thermoplastic or Metal housing (Cable Plugs)
- UL, cUL recognized components (File no. E339831)
- Industry standard mating



Part Number Breakdown: Page 60

Specifications: Page 64









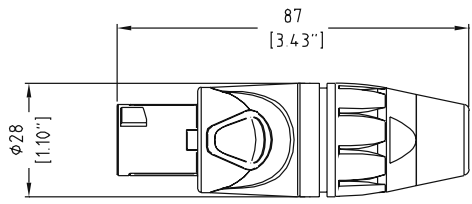

PCB Footprints: Page 62

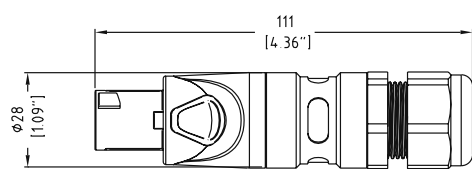
Assembly Instructions: 63

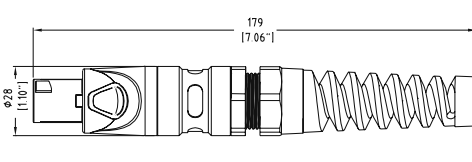
PRODUCT - FIGURE	DRAWING	Dimensions in mm (inches)	DESCRIPTION	CONTACT TYPE	SHELL COLOUR	PART NUMBER
			2 pole, Cable connector, Thermoplastic shell, Blue sleeve	Screw	Black	SP-2-F
				Solder	Black	SP-2-FS
			2 pole, Cable connector, Thermoplastic shell, Blue sleeve, PG Gland	Screw	Black	SP-2-FG
				Solder	Black	SP-2-FSG
			2 pole, Cable connector, Thermoplastic shell, Blue sleeve, PG Gland strain relief	Screw	Black	SP-2-FL
				Solder	Black	SP-2-FSL
			2 pole, Cable connector, Metal shell, Blue sleeve	Screw	Nickel	SP-2-FN
				Solder	Nickel	SP-2-FNS
				Screw	Black	SP-2-FB
				Solder	Black	SP-2-FBS
			2 pole, Cable connector, Metal shell, Blue sleeve, PG Gland	Screw	Nickel	SP-2-FNG
				Solder	Nickel	SP-2-FNSG
				Screw	Black	SP-2-FBG
				Solder	Black	SP-2-FBSG
			2 pole, Cable connector, Metal shell, Blue sleeve, PG Gland strain relief	Screw	Nickel	SP-2-FNL
				Solder	Nickel	SP-2-FNSL
				Screw	Black	SP-2-FBL
				Solder	Black	SP-2-FBSL

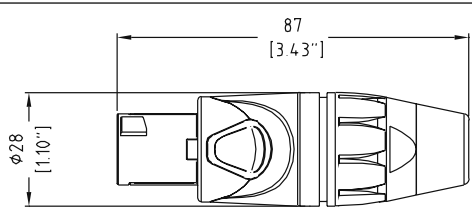

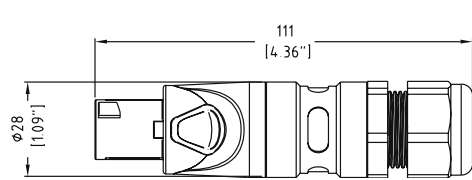

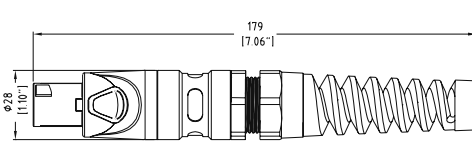

Speaker Connectors

SP Series

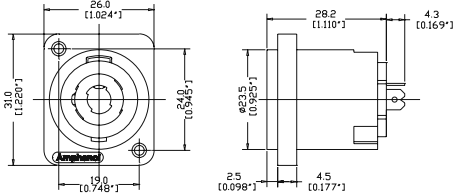
PRODUCT - FIGURE	DRAWING	DESCRIPTION	CONTACT TYPE	SHELL COLOUR	PART NUMBER
		4 pole, Cable connector, Thermoplastic black shell, Blue sleeve	Screw	Black	SP-4-F
			Solder	Black	SP-4-FS
		4 pole, Cable connector, Thermoplastic black shell, Blue sleeve, PG Gland	Screw	Black	SP-4-FG
			Solder	Black	SP-4-FSG
		4 pole, Cable connector, Thermoplastic black shell, Blue sleeve, PG Gland strain relief	Screw	Black	SP-4-FL
			Solder	Black	SP-4-FSL
		4 pole, Cable connector, Metal shell, Blue sleeve	Screw	Nickel	SP-4-FN
			Solder	Nickel	SP-4-FNS
			Screw	Black	SP-4-FB
			Solder	Black	SP-4-FBS
		4 pole, Cable connector, Metal shell, Blue sleeve, PG Gland	Screw	Nickel	SP-4-FNG
			Solder	Nickel	SP-4-FNSG
			Screw	Black	SP-4-FBG
			Solder	Black	SP-4-FBSG
		4 pole, Cable connector, Metal shell, Blue sleeve, PG Gland strain relief	Screw	Nickel	SP-4-FNL
			Solder	Nickel	SP-4-FNSL
			Screw	Black	SP-4-FBL
			Solder	Black	SP-4-FBSL

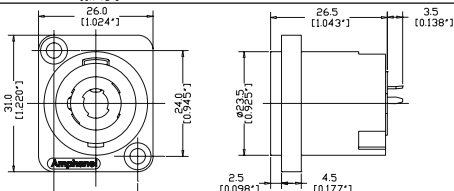

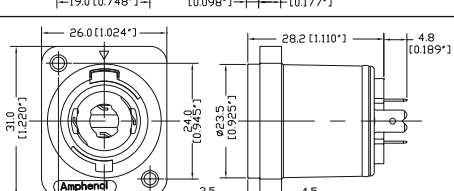
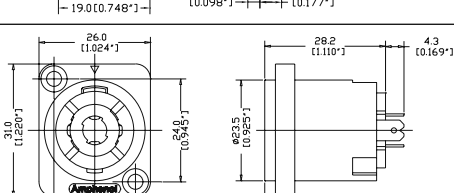

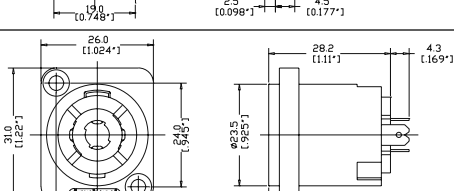
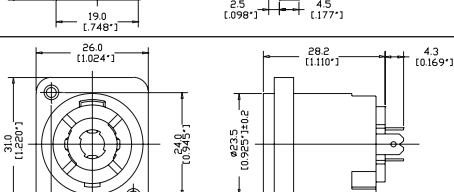





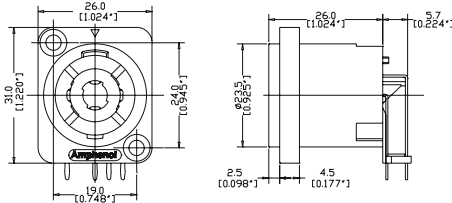

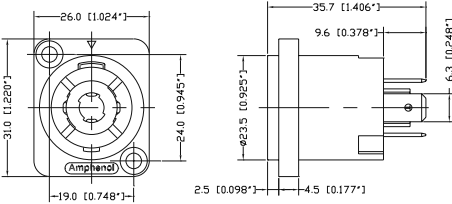

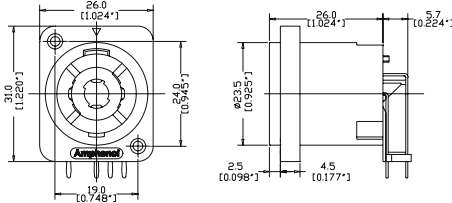
Speaker Connectors

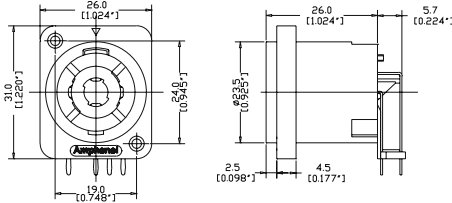
SP Series

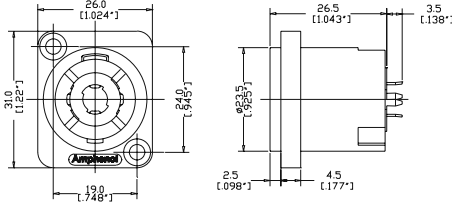
PRODUCT - FIGURE	DRAWING	Dimensions in mm (inches)	DESCRIPTION	VARIATIONS	PART NUMBER
			2 pole, D flange, Thru holes, Solder tabs 3/16"	Black	SP-2-MD
			2 pole, D flange, Thru holes, Horizontal PCB	Black	SP-2-MDH
			2 pole, D flange, Thru holes, Vertical PCB	Black	SP-2-MDV
			Airtight 4 pole, D flange Self Tapping holes, Solder Tabs 3.16"	Black	SP-4-MDAT
			Airtight 4 pole, D flange Thru holes, Solder tabs 3/16"	Black	SP-4-MDA
			4 pole, D flange, Thru holes, Solder tabs 3/16"	Black	SP-4-MD
			4 pole, D flange, Thru holes, Solder tabs 3/16"	Grey	SP-4-MD-8
			4 pole, D flange, Self Tapping holes, Solder tabs 3/16"	Black	SP-4-MDT

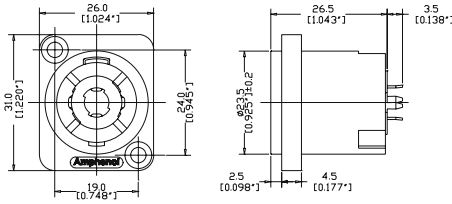
Speaker Connectors

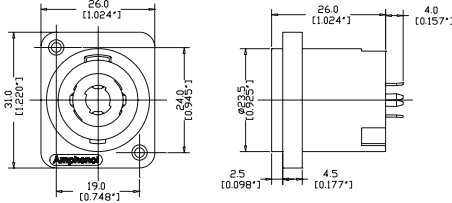
SP Series

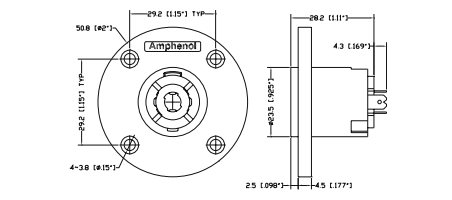
PRODUCT - FIGURE	DRAWING	Dimensions in mm (inches)	DESCRIPTION	VARIATIONS	PART NUMBER
			4 pole, D flange, Thru holes, Horizontal PCB	Black	SP-4-MDH
			4 pole, D flange, Thru holes, Solder tabs 1/4"	Black	SP-4-MDQ
			4 pole, D flange, Self Tapping holes, Horizontal PCB	Grey	SP-4-MDHT-8
			4 pole, D flange, Self Tapping holes, Horizontal PCB	Black	SP-4-MDHT
			4 pole, D flange, Thru holes, Vertical PCB	Black	SP-4-MDV
			4 pole, D flange, Thru holes, Vertical PCB	Red	SP-4-MDV-2
			4 pole, D flange, Self Tapping holes, Vertical PCB	Grey	SP-4-MDVT-8
			4 pole, EP flange, Thru holes, Solder tabs 3/16"	Black	SP-4-MC

Speaker Connectors

SP Series

PART NUMBER BREAKDOWN

SP SERIES - CABLE CONNECTORS

E. G . **SP-4-FNSG**
SP (Series Prefix), **4** contacts, **F** (Cable Connector), **N** (Metal Shell Nickel Finish),
S (Solder Terminals), **G** (PG Gland)

SERIES PREFIX	SP	=	Series Prefix
CONTACT LAYOUT	2	=	2 Contacts
	4	=	4 Contacts
GENDER	F	=	Cable Connector
SHELL FINISH	Blank	=	Thermoplastic - Black
	N	=	Metal - Nickel Finish
	B	=	Metal - Black Finish
TERMINATION	Blank	=	Screw Terminals
	S	=	Solder Terminals
BACKSHELL TYPE	Blank	=	Standard
	G	=	PG Gland
	L	=	PG Gland Strain Relief
PACKAGING	Blank	=	Individual Bags
	B	=	Bulk Packed
	B1	=	Supplied with small and large cable clamps

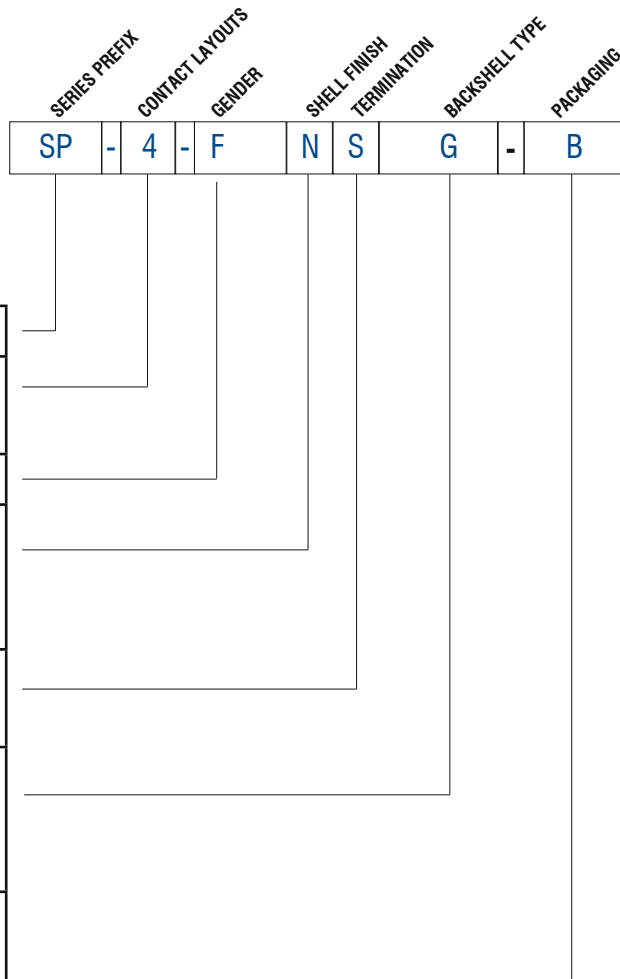

PART NUMBER BREAKDOWN

SP SERIES - CHASSIS CONNECTORS

E. G . **SP-4-MDHT-8B**
SP (Series Prefix), **4** contacts, **M**(Chassis Connector), **D** (D Shell), **H**orizontal Printed Circuit Board, **T**apping mounting holes - **8** (Grey), **B**ulk Packaged.

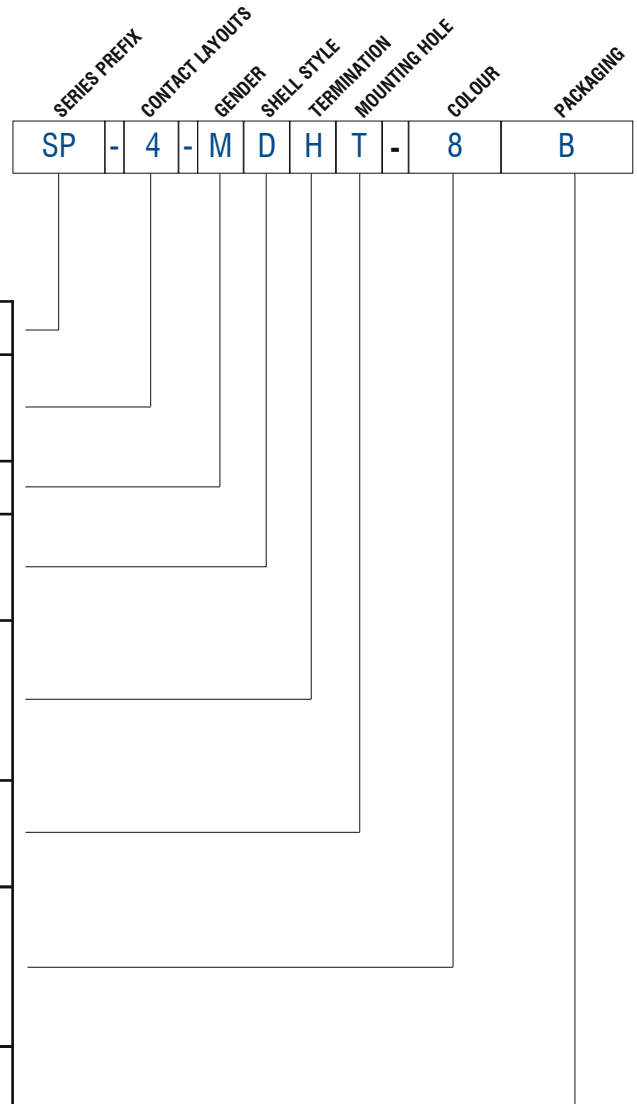

SERIES PREFIX	SP	=	Series Prefix
CONTACT LAYOUT	2	=	2 Contacts
	4	=	4 Contacts
GENDER	M	=	Chassis Connector
SHELL STYLE	D	=	Standard 'D' Type flange
	C	=	EP Series Circular flange
TERMINATION	Blank	=	Solder tabs - 3/16" terminals
	Q	=	Solder tabs - 1/4" terminals
	V	=	Vertical Printed Circuit Board
	H	=	Horizontal Printed Circuit Board
MOUNTING HOLE	Blank	=	Thru Hole
	T	=	Self Tapping
SHELL COLOUR	Blank	=	Black
	2	=	Red
	8	=	Grey
PACKAGING	Blank	=	Individual Bags
	B	=	Bulk Packed

Speaker Connectors

SP Series

SP SERIES

SP-2-MDH

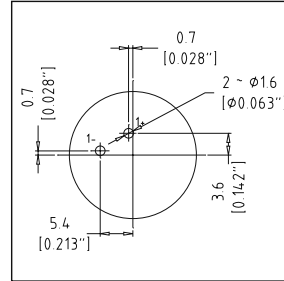
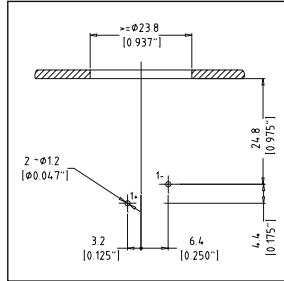

SP-2-MDV

SP-4-MDH
SP-4-MDHT-8
SP-4-MDHT

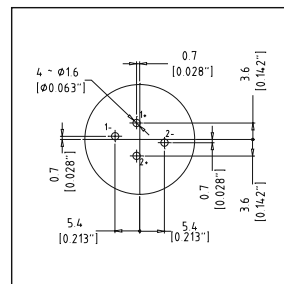
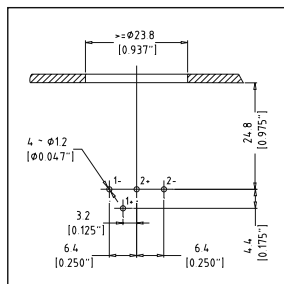

SP-4-MDV
SP-4-MDV-2
SP-4-MDVT-8

SP SERIES PANEL CUTOUT

SP-2-MD** *
SP-4-MD** *

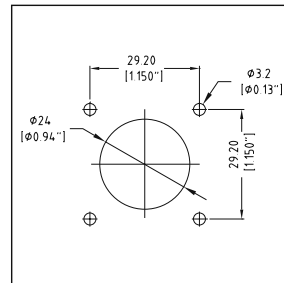
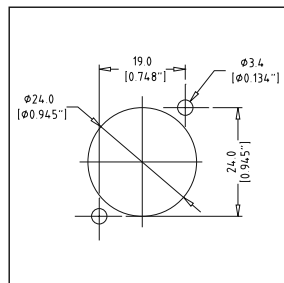

SP-4-MC

PI 1070 ASSEMBLY INSTRUCTIONS

SP SERIES CABLE CONNECTOR



Slide the nut onto the cable

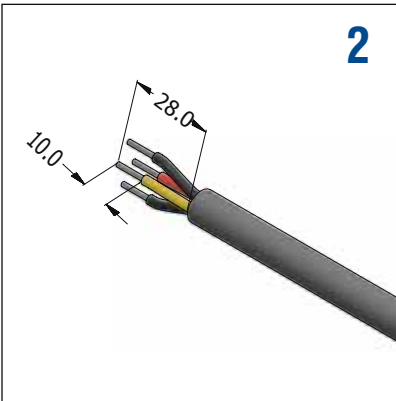

Strip the cable and twist the conductors.

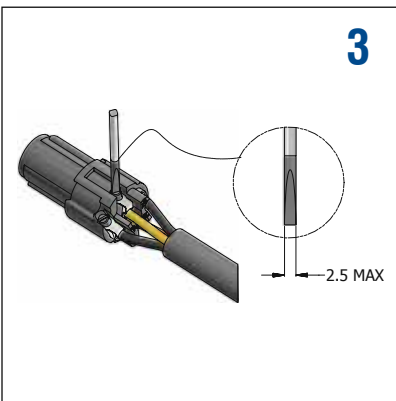

Insert the conductors into the rear of contacts on the insert. Tighten the screws to 0.35Nm (3.0 lb-in) using a flat screwdriver with tip width of 2.5mm max.



Install the cable clamp, flush to the insert making sure to align the slot as shown in the picture.

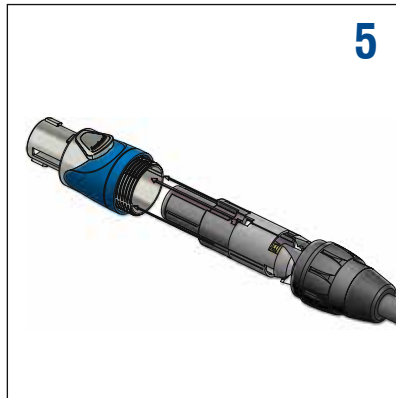

Orientate the insert and cable clamp as shown then push all together into the shell.

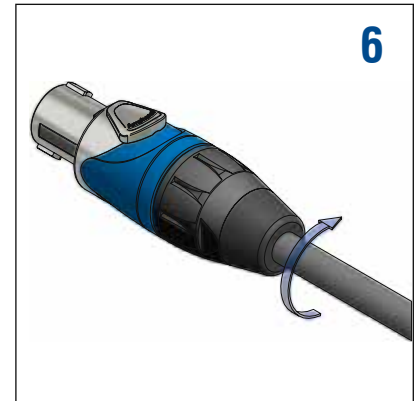

Thread the nut onto the shell to activate the cable clamp and close the connector assembly.

Speaker Connectors

SP Series

STANDARD DATA SP SERIES CONNECTORS

		VALUE	
GENERAL CHARACTERISTICS	Number of contacts	2 or 4	
	Termination (Chassis)	Printed Circuit Board (PCB) or Solder Tabs 3/16"	
	Termination (Cable Plugs)	Screw or Solder Terminals	
	Flammability	UL94HB	
	Environmental	Complies with EU RoHS 2 Directive 2011/65/EU	
ELECTRICAL CHARACTERISTICS	Service Voltage RMS	133V ¹⁾	
	Test Voltage AC RMS	1500V	
	Current carrying capacity	20A	
	Typical Contact Resistance	≤3mΩ	
	Insulation Resistance (initial)	≥2GΩ	
	Insulation Resistance (after damp heat test)	≥1GΩ	
CLIMATIC CHARACTERISTICS	Protection Class (Mated Condition)	IP20 (IP40)	
	Operating Temperature	-25 °C to +75 °C (-13°F to +167°F)	
MECHANICAL CHARACTERISTICS	Weight** - Chassis Connectors	12g (0.026lb)	
	Weight** - Cable Plug - Thermoplastic - Metal	44g (0.097lb) 65g (0.143lb)	
		Weight** - Cable Plug PG - Thermoplastic - Metal	44g (0.097lb) 65g (0.143lb)
	Weight** - Cable Plug PG S/Relief - Thermoplastic - Metal		68g (0.150lb) 89g (0.196lb)
		Typical Cable retention force	200N (Subject to cable material and O.D.)
	Cable O.D range - Chuck Clamp - PG16 Gland - PG16 Gland S/Relief	2 pole 5-10mm (0.19" - 0.39") 6-12mm (0.23" - 0.47") 9-14mm (0.35" - 0.55")	4 pole 9-14mm (0.35" - 0.55") 8-14mm (0.31" - 0.55") 9-14mm (0.35" - 0.55")
		Conductor Size - Screw Terminals - Solder Bucket	1.5mm ² - 4mm ² (AWG16 - AWG12) 1.5mm ² - 6mm ² (AWG16 - AWG10)
		Mechanical Operations	5000 mating cycles
MATERIALS	Connector Shell / Finish - Cable Plug Thermoplastic - Cable Plug Metal	PA66 GF30 / Black Diecast Zinc Alloy / Nickel or Black	
	Insulators - Chassis - Cable Plugs	PA66 GF20 PA66 GF30	
	Cable Boot / Backshell	Santoprene / PA6 GF 15	
	Cable Clamp (Chuck)	P.O.M	
	Cable Clamp (PG)	Polyemide / EPDM	
	Sleeve	PBT	
	Contact Chassis - Material / Plating Contact Cable Plug - Material / Plating	Phosphor Bronze / Silver Brass / Silver	

Rev 7 - 12/2020

**Approximate weight in grams not including packaging. Please contact us for exact weight for shipping purposes.

¹⁾Not suitable for domestic applications above 50V



EP SERIES

The EP Series has set the standard in high performance speaker connectors. Apart from its durability and strength, it offers consistent superior power handling capabilities.



Features:

- Solder Bucket connections.
- Precision machined contacts.
- Diecast Metal Housings
- High current contacts
- Male and female cable and chassis connectors available.

Options: Black Finish Shell



Specifications: Page 68

Panel Cutouts: Page 69

PRODUCT - FIGURE	DRAWING	Dimensions in mm (inches)	DESCRIPTION	VARIATIONS	PART NUMBER
 <p>ISO ASSEMBLY OF EP MALE</p>		<p>EP Male cable connector, Machined contacts, Metal Shell</p>	3 pole nickel finish	EP-3-12	
			3 pole black finish	EP-3-12B	
			4 pole nickel finish	EP-4-12	
			4 pole black finish	EP-4-12B	
			5 pole nickel finish	EP-5-12	
			5 pole black finish	EP-5-12B	
			6 pole nickel finish	EP-6-12	
			6 pole black finish	EP-6-12B	
			8 pole nickel finish	EP-8-12	
			8 pole black finish	EP-8-12B	
 <p>ISO ASSEMBLY OF EP FEMALE</p>		<p>EP Female cable connector, Machined contacts, Metal Shell</p>	3 pole nickel finish	EP-3-11P	
			3 pole black finish	EP-3-11PB	
			4 pole nickel finish	EP-4-11P	
			4 pole black finish	EP-4-11PB	
			5 pole nickel finish	EP-5-11P	
			5 pole black finish	EP-5-11PB	
			6 pole nickel finish	EP-6-11P	
			6 pole black finish	EP-6-11PB	
			8 pole nickel finish	EP-8-11P	
			8 pole black finish	EP-8-11PB	

Speaker Connectors

EP Series

PRODUCT - FIGURE	DRAWING	DESCRIPTION	VARIATIONS	PART NUMBER
		EP Male chassis mount, Round Flange, Machined contacts, Metal Shell	3 pole nickel finish	EP-3-14
			3 pole black finish	EP-3-14B
			4 pole nickel finish	EP-4-14
			4 pole black finish	EP-4-14B
			5 pole nickel finish	EP-5-14
			5 pole black finish	EP-5-14B
			6 pole nickel finish	EP-6-14
			6 pole black finish	EP-6-14B
			8 pole nickel finish	EP-8-14
8 pole black finish	EP-8-14B			
		EP Female chassis mount, Round Flange, Machined contacts, Metal Shell	3 pole nickel finish	EP-3-13P
			3 pole black finish	EP-3-13PB
			4 pole nickel finish	EP-4-13P
			4 pole black finish	EP-4-13PB
			5 pole nickel finish	EP-5-13P
			5 pole black finish	EP-5-13PB
			6 pole nickel finish	EP-6-13P
			6 pole black finish	EP-6-13PB
			8 pole nickel finish	EP-8-13P
8 pole black finish	EP-8-13PB			



AP SERIES

The AP Series provides the same power handling performance as the EP Series in a cost effective, yet durable Thermoplastic housing.

Features:

- Solder Bucket connections.
- Precision machined contacts.
- Thermoplastic Housings
- High current contacts
- Male & Female Cable and Chassis connectors available.

Specifications: [Page 68](#)

Panel Cutouts: [Page 69](#)

PRODUCT - FIGURE	DRAWING	Dimensions in mm (inches)	DESCRIPTION	VARIATIONS	PART NUMBER
			AP Male cable connector, Machined contacts, Thermoplastic Black shell.	4 pole	AP-4-12
				5 pole	AP-5-12
				6 pole	AP-6-12
				8 pole	AP-8-12
			AP Female cable connector, Machined contacts, Thermoplastic Black shell.	4 pole	AP-4-11
				5 pole	AP-5-11
				6 pole	AP-6-11
				8 pole	AP-8-11
			AP Male chassis mount, Rectangular Flange, Machined contacts, Thermoplastic Black shell.	4 pole	AP-4-22
				5 pole	AP-5-22
				6 pole	AP-6-22
				8 pole	AP-8-22
			AP Female chassis mount, Rectangular Flange, Machined contacts, Thermoplastic Black shell.	4 pole	AP-4-21
				5 pole	AP-5-21
				6 pole	AP-6-21
				8 pole	AP-8-21

STANDARD DATA EP/AP

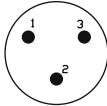
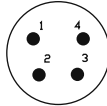
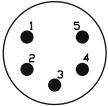
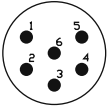
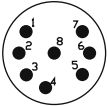
		VALUE				
GENERAL CHARACTERISTICS	Number of contacts	3	4	5	6	8
	Contact Arrangements (Front view of pin insert)					
	Termination	SOLDER				
	Wire Gauge - Stranded wire:	12AWG	12AWG	12AWG	12AWG	14AWG
	Flammability	UL94V-0				
	Environmental	Complies with EU RoHS 2 Directive 2011/65/EU				
ELECTRICAL CHARACTERISTICS	Service Voltage RMS ¹⁾	460V	660V	200V	200V	100V
	Test Voltage AC RMS	2400V	3000V	1600V	1600V	1300V
	Current carrying capacity	20A	20A	20A	20A	15A
	Typical Contact Resistance	≤3mΩ				
	Insulation Resistance	≥1000MΩ				
CLIMATIC CHARACTERISTICS	Protection Class	IP40				
	Operating Temperature	-25 °C to +75 °C (-13°F to +167°F)				
MECHANICAL CHARACTERISTICS	Weight - EP 11 & 12 ²⁾	80g (0.176lb)	84g (0.185lb)	86g (0.189lb)	86g (0.189lb)	86g (0.189lb)
	Weight - EP 13 & 14 ²⁾	48g (0.105lb)	50g (0.110lb)	54g (0.119lb)	54g (0.119lb)	54g (0.119lb)
	Weight - AP 11 & 12 ²⁾	N/A	42g (0.092lb)	44g (0.097lb)	44g (0.097lb)	44g (0.097lb)
	Weight - AP 13, 14, 21 & 22 ²⁾	N/A	26g (0.057lb)	30g (0.066lb)	30g (0.066lb)	28g (0.061lb)
	Typical Cable retention force	22Kg to 44Kg (50lb to 100lb) - Dependant on cable material and diameter				
	Mechanical operations	1000 mating cycles				

¹⁾ Not suitable for domestic applications above 50V

²⁾ Approximate weight only, does not include packaging. Please contact us for exact weight for shipping purposes.

STANDARD DATA EP/AP (CONT'D)

		DETAILS	
MATERIALS	TYPE	AP	EP
	Connector shell	Modified PPE Resin	Diecast Zinc Alloy
	Shell finish	Black	Satin Nickel or Black
	Insulators	UL94V-0 PBT Resin	
	Cable Bushing	Silicon Rubber	UL94 HB Thermoplastic Elastomer
	Male contact Machined - Solder	Brass / Bright Tin	
	Material / Plating		
	Female contact Machined - Solder	Brass / Bright Tin	
	Material / Plating		
CLAMPING CHARACTERISTICS	Cable OD Range	11mm to 17mm (0.43" to 0.67")	9mm to 16mm (0.35" to 0.63")
	Retention Method	Two opposing plastic screws	Metal saddle clamp

Rev 3 - 03/2013

EP/AP SERIES PANEL CUTOUT DATA - FRONT VIEW

EP 13/AP 13/AP 21

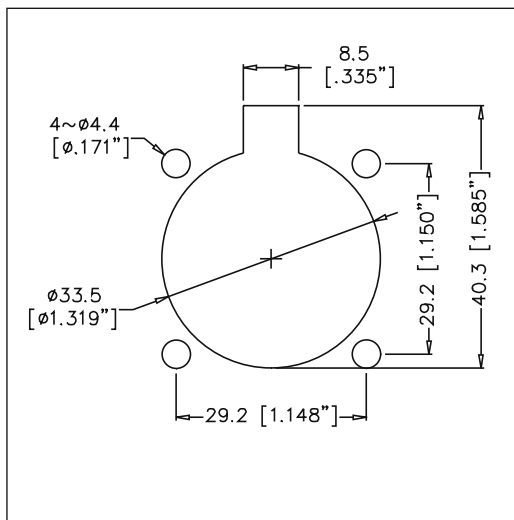

EP 14/AP 14/AP 22

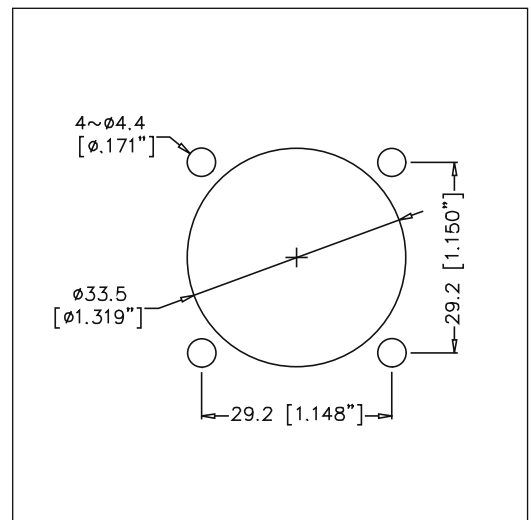



HP SERIES

HP Series connectors are suitable for AC power supply where a latch locking connector is required. They are rated at 25 A / 250 Vac. Connectors are keyed and colour coded for power-in (Blue) and power-out (Grey).

⚡ THE HP SERIES OF CONNECTORS ARE NOT DESIGNED TO BE "HOT PLUGGED" AND SO ARE WITHOUT "BREAKING CAPACITY". IN OTHER WORDS, THE CONNECTORS SHOULD NOT BE CONNECTED OR DISCONNECTED LIVE OR WHEN UNDER LOAD

Features:

- Quick release, vibration resistant latch lock
- 3 pole
- Screw Terminals or Solder Tab 3/16"
- Chuck type cable clamp
- 25A Current rating
- Thermoplastic housing
- Industry standard mating
- UL, cUL recognized components (File no. E339831)



PRODUCT	DRAWING Dimensions in mm (inches)	DESCRIPTION	CONTACT TYPE	SHELL COLOUR	PART NO.
		3 pole, Cable connector, Thermoplastic shell, Blue sleeve, keyed for power-in	Screw	Blue	HP-3-F
		3 pole, Cable connector, Thermoplastic shell, Grey sleeve, keyed for power-out	Screw	Grey	HP-3-FG
		3 pole, Chassis connector, Thermoplastic shell, Blue, keyed for power-in	Solder Tab 3/16"	Blue	HP-3-MD
		3 pole, Chassis connector, Thermoplastic shell, Grey, keyed for power-out	Solder Tab 3/16"	Grey	HP-3-MDG
		3 pole, Chassis connector, Thermoplastic shell, Blue, keyed for power-in, without insulation divider	Solder Tab 3/16"	Blue	HP-3-MDW
		3 pole, Chassis connector, Thermoplastic shell, Grey, keyed for power-out, without insulation divider	Solder Tab 3/16"	Grey	HP-3-MDGW

STANDARD DATA HP SERIES CONNECTORS

		VALUE
GENERAL CHARACTERISTICS	Number of contacts	2 + PE
	Termination	Screw or Solder Tab 3/16"
	Flammability	UL94V-0
	Environmental	Complies with EU RoHS 2 Directive 2011/65/EU
ELECTRICAL CHARACTERISTICS	Rated Operating Voltage	250VAC
	Test Voltage AC RMS	3200V
	Current carrying capacity	25A
	Typical Contact Resistance	≤3mΩ
	Insulation Resistance (initial)	≥2GΩ
	Insulation Resistance (after damp heat test)	≥1GΩ
CLIMATIC CHARACTERISTICS	Protection Class	IP20
	Operating Temperature	-25 °C to +75 °C (-13°F to +167°F)
MECHANICAL CHARACTERISTICS	Weight** - Chassis Connector - Cable Plug	12g (0.026lb) 32g (0.070lb)
	Typical Cable retention force	200N (Subject to cable material and O.D.)
	Cable O.D range - Blue Chuck Clamp - Black Chuck Clamp	5mm - 7.5mm (0.19" - 0.29") 7.5mm - 15mm (0.29" - 0.59")
	Conductor Size - Screw Terminals	2.5mm ² (AWG14)
	MATERIALS	Connector Shell / Finish
Insulators		PA66 GF30
Cable Boot / Backshell		Santoprene / PBT
Cable Clamp (Chuck)		P.O.M
Contact Plug - Material / Plating		Brass / Silver
Contact Chassis - Material / Plating		Phosphor Bronze / Silver

Rev 4 - 08/2016

**Approximate weight in grams not including packaging. Please contact us for exact weight for shipping purposes.

Power Connectors

HPT Series



HPT SERIES

HPT Series connectors are suitable for AC power supply where a durable latch locking connector is required. They are rated at 16A, 250 Vac. HPT Series connectors can be connected or disconnected under load and are IP65 rated.



Features:











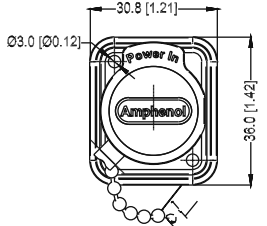

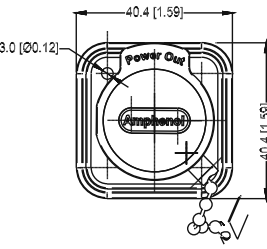
- 2 + PE contact layout
- Quick release, vibration resistant latch lockable
- High impact UV resistant material
- True Mains Connector with Current Breaking Capacity (CBC)
- 16A current rating (20A USA)
- Industry standard mating interface
- IP65 rated
- Patent Protected*
- UL498 certified
- UL50E enclosure type 4 (when mated or in combination with protective caps)

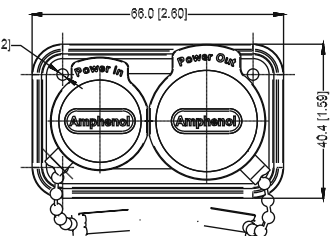
PRODUCT - FIGURE	DRAWING	Dimensions in mm (inches)	DESCRIPTION	CONTACT TYPE	SHELL COLOUR	PART NUMBER
			3 pole, Outlet Cable connector, Locking, Thermoplastic shell, Screw terminals, Lockable backshell	Screw	Black	HPT-3-F
			3 pole, Outlet Cable connector, Locking, Thermoplastic shell, Screw terminals	Screw	Black	HPT-3-FJ
			3 pole, Inlet Cable connector, Locking, Thermoplastic shell, Screw terminals, Lockable backshell	Screw	Black	HPT-3-M
			3 pole, Inlet Cable connector, Locking, Thermoplastic shell, Screw terminals	Screw	Black	HPT-3-MJ
			3 pole, Chassis Inlet connector, Thermoplastic shell, 1/4\" flat tab terminals	Tab 1/4"	Black/ Yellow	HPT-3-MD
			3 pole, Chassis Inlet connector, Thermoplastic shell, without insulation divider, 1/4\" flat tab terminals	Tab 1/4"	Black/ Yellow	HPT-3-MDW
			3 pole, Chassis Outlet connector, Thermoplastic shell, 1/4\" flat tab terminals	Tab 1/4"	Black/ Yellow	HPT-3-FD
			3 pole, Chassis Outlet connector, Thermoplastic shell, without insulation divider, 1/4\" flat tab terminals	Tab 1/4"	Black/ Yellow	HPT-3-FDW
			3 pole, Chassis Inlet-Outlet combination, Thermoplastic shell, 1/4\" flat tab terminals	Tab 1/4"	Black/ Yellow	HPT-3-CC

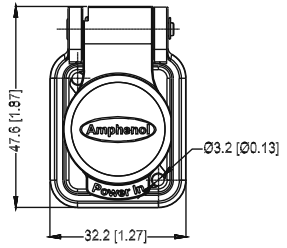
*Patent Protected refer to <http://www.amphenolaudio.com/patents/>

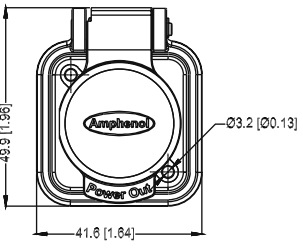
Power Connectors

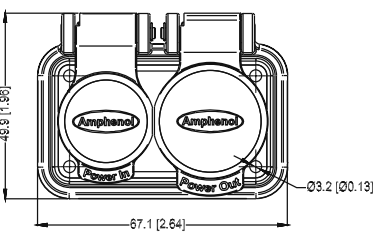
HPT Series

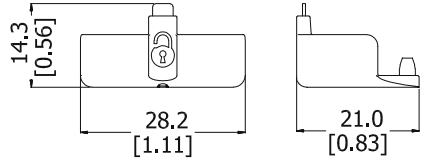
PRODUCT - FIGURE	DRAWING	DESCRIPTION	COLOUR	PART NUMBER
		Protective sealing cap with stainless steel lanyard to suit HPT-3-MD / HPT-3-MDW	Black	HPT-CAPM
		Protective sealing cap with stainless steel lanyard to suit HPT-3-FD / HPT-3-FDW	Black	HPT-CAPF
		Protective sealing cap with stainless steel lanyard to suit HPT-3-CC	Black	HPT-CAPD
		Protective Self-closing sealing cap with stainless steel spring to suit HPT-3-MD / HPT-3-MDW	Black	HPT-CAPSM
		Protective Self-closing sealing cap with stainless steel spring to suit HPT-3-FD / HPT-3-FDW	Black	HPT-CAPSF
		Protective Self-closing sealing cap with stainless steel spring to suit HPT-3-CC	Black	HPT-CAPSD
		Cable connector backshell lock release tool	Black	HPT-RT

Power Connectors

HPT Series

STANDARD DATA HPT SERIES CONNECTORS

		VALUE
GENERAL CHARACTERISTICS	Number of contacts	2 + PE
	Termination - Cable Connector - Chassis Mount	2mm Hex key screw terminal Flat Tab 1/4"
	Flammability	UL94V-0
	Environmental	Complies with EU RoHS 2 Directive 2011/65/EU
ELECTRICAL CHARACTERISTICS	Rated Operating Voltage	250VAC
	Test Voltage AC RMS	1500V
	Current carrying capacity	16A (20A USA)
	Typical Contact Resistance	≤2mΩ
	Insulation Resistance (initial)	≥2GΩ
	Insulation Resistance (after damp heat test)	≥0.1GΩ
	Breaking Cycles	5000
CLIMATIC CHARACTERISTICS	Protection Class	IP65, UL50E enclosure type 4 (in mated or in combination with protective caps)
	Operating Temperature	-25 °C to +80 °C (-13°F to +176°F)
MECHANICAL CHARACTERISTICS	Weight** - Chassis Connector - Cable Plug	15g (0.033lb) / 25g (0.055lb) 40g (0.088lb)
	Typical Cable retention force	Subject to cable material and O.D.
	Cable O.D range	6.0 -12.0 mm with lockable backshell 7.5 -16.0 mm with non-lockable backshell
	Conductor Size - Screw Terminals	2.5mm ² (AWG12)
	Mating Cycles	5000
MATERIALS	Connector Shell / Finish	PA66 GF30 / Black
	Insulators	PA66 GF30
	Cable Boot / Backshell	Neoprene / PBT
	Contact Plug - Material / Plating	Copper Alloy / Silver
	Contact Chassis - Material / Plating	Copper Alloy / Silver
	Protective Caps - Base - Overmolded Cap - Chain	Santoprene, UV resistant PA66 & Santoprene, UV resistance Stainless Steel SS304
	Protective Caps (Self closing) - Base - Overmolded Cap - Gasket - Spring	Polycarbonate, UV resistant Polycarbonate & Santoprene, UV resistant Silicone Rubber Stainless Steel SS304

Rev 5 - 03/2023

**Approximate weight in grams not including packaging. Please contact us for exact weight for shipping purposes.

AMPHE-DANTE ADAPTERS

Amphe-Dante are Dante™ audio to analogue audio adapters, available for Input, Output, AES3 and USB applications. Featuring premium quality Amphenol AX series XLR and RJ45 connectors in a robust molded housing.

Amphe-Dante products enable simple connection of analogue equipment to a Dante network and can receive and transmit audio channels from a Dante network and provide studio-quality, low-latency audio via XLR connectors to and from analogue audio equipment.



Amphe-Dante feature high-quality digital-to-analogue converters, and support a range of sample rates and bit depths. They can provide a hardware master clock for a Dante network. As with other Dante products, the freely available Dante Controller software application is used to automatically discover and configure Amphe-Dante devices connected to the Dante network. Device names, channel labels, signal routing and other parameters (for example, sample rate and latency) can be configured via the network using Dante Controller. A variety of network and clock synchronisation diagnostic tools are also available in Dante Controller.

Amphe-Dante products use Power over Ethernet (PoE). Power can be provided through the Ethernet cable from a PoE-capable network switch, or from a separate PoE injector.

Available Software Options (required)

Dante Controller

Dante Controller is a free software application that enables you to route audio and configure devices on a Dante network. As well as automatic device discovery, one-click signal routing and user-editable device and channel labels, Dante Controller provides essential device status information and powerful real-time network monitoring, including device-level latency and clock stability stats, multicast bandwidth usage, and customized event logging, enabling you to quickly identify and resolve any potential network issues.

Dante Via

Dante Via is powerful and easy-to-use software that delivers unprecedented routing of computer-based audio, allowing a wide range of applications and devices to be networked and interconnected, easily and inexpensively. Dante Via network-enables locally-connected USB and Firewire devices, and a huge range of software applications, allowing you to route computer-based audio across an existing Dante network, and create standalone Dante networks without dedicated Dante hardware.

Dante Virtual Soundcard

Dante Virtual Soundcard turns your computer into a Dante-powered workstation, seamlessly integrating your PC or Mac with Dante audio devices on your network. You can instantly connect to a Dante network to record, process and playout using any audio application and any combination of Dante-enabled devices.

Dante Controller



All software can be purchased and downloaded at amphenolaudio.com/products/dante

Dante™ is a trademark of Audinate Pty Ltd. Audinate® is a registered trademark of Audinate Pty Ltd.

Data Connectors

Amphe-Dante Adapters



Features:

- Dante™ to analogue XLR output adapters
- Line level analogue input to Dante™ audio output adapters
- Dante™ AES3 2 channel input/output adapters
- Dante™ USB input/output adapters
- One channel or Two channel analogue input or output
- Durable overmolded housing
- Resilient cable strain relief
- Shielded RJ45 metal connectors with integrated LED's
- Premium AX Series XLR connectors

PRODUCT	DRAWING Dimensions in mm (inches)	DESCRIPTION	PART NO.
ANALOGUE OUTPUT			
		Analogue Output - 1 channel, RJ45 input to XLR output, Durable overmolded housing 	RJD1112-0050
		Analogue Output - 2 channel, RJ45 input to XLR output, Durable overmolded housing 	RJD1212-0050
ANALOGUE INPUT			
		Analogue line level Input - 1 channel, XLR input to RJ45 output, Durable overmolded housing 	RJD2103-0050
		Analogue line level Input - 2 channel, XLR input to RJ45 output, Durable overmolded housing 	RJD2203-0050
AES3			
		AES3 Input / Output - 2 channel, XLR I/O to RJ45 I/O, Durable overmolded housing 	RJD32A3-0050
USB			
		USB Input / Output - 2 channel, USB I/O to RJ45 I/O, Durable overmolded housing 	RJD32U1-0050

SPECIFICATIONS

		ANALOG INPUT 1CH	ANALOG INPUT 2CH	ANALOG OUTPUT 1CH	ANALOG OUTPUT 2CH	AES3 I/O 2 IN 2 OUT	USB I/O 2 IN 2 OUT	
GENERAL	Connectors	1 XLR-F	2 XLR-F	RJ45	RJ45	RJ45	RJ45	
		RJ45	RJ45	1 XLR-M	2 XLR-M	1 XLR-M, 1 XLR-F	USB 2.0 Type A	
ELECTRICAL	Power Consumption	< 2 Watt						
	Power over Ethernet (Required)	Class 1 IEEE 802.3af POE PD compliant						PoE or USB
ANALOG / DIGITAL AUDIO	Max Signal Level (Balanced)	+24dBu / +4dBu / 0dBu / -10dBV		+18dBu / +4dBu / 0dBu / -10dBV		-	-	
	Impedance	20k Ohm balanced 10k Ohm unbalanced		150 Ohm balanced 75 Ohm unbalanced		110 Ohm balanced	-	
	Frequency Response	20Hz to 20 kHz (+/-0.5db)		20Hz to 20 kHz (+/-0.5db)		-	-	
	Dynamic Range	> 100dB		> 100dB		-	-	
	Signal to Noise	> 100dB		> 100dB		> 135dB	-	
	Total Harmonic Distortion	< 0.01% at +4dBu		< 0.01% at +4dBu		-	-	
	Channel Separation	N/A	> 100 dB	N/A	> 100 dB		-	
	Channel Matching	N/A	< 0.25 dB	N/A	< 0.25 dB		-	
DANTE® AUDIO	Asynchronous Sample Rate Conversion	-		-		Yes	-	
	Sample Rate	44.1 kHz, 48 kHz (default), and 96 kHz						48 kHz
	Bit Depth	24 bits						
	Network Speed	100 Mbps						
	Network Interface	Latency from 1ms						
	Network Transport	Dante Audio over IP, AES67 RTP						
CLIMATIC	Protection Class	IP40						
	Operating Temperature	-5°C to +60°C (23°F to +140°F)						
MECHANICAL	Insertion and Withdrawal Force	≥10N - ≤35N						
	Weight	136g (0.299lb)	192g (0.423lb)	136g (0.299lb)	192g (0.423lb)	192g (0.423lb)	110g (0.243lb)	
MATERIALS	Housing	PVC 60P Black						

Rev 4 - 09/2018

LED STATUS

LEFT LED RIGHT LED



FUNCTION	LEFT LED	RIGHT LED	COMMENT
Off	OFF	OFF	No Power
Device is booting	Solid GREEN	Solid RED	
Slave with sync	Blinking GREEN	Solid GREEN	Normal operation
Clock Master	Blinking GREEN	Blinking GREEN	Normal operation
Any runtime error	Blinking GREEN	Blinking RED	Normal operation
Identify	Alternating RED and GREEN	Alternating RED and GREEN	Blinking for 6 seconds (cycle every 0.5 seconds)
Failsafe (bootloader)	Blinking RED	Blinking RED	Failsafe, Corrupt Capability (red in DC)
Upgrade (bootloader)	Blinking ORANGE	Blinking ORANGE	Device is upgrading



XLRnet Connectors

XLRnet was designed in conjunction with the Amphenol Data / Telecom product group of Amphenol Canada Corp., a subsidiary of Amphenol Corporation. Utilising our combined expertise and knowledge of the professional audio and high-speed data markets we are proud to offer the XLRnet series. Featuring Class D (10/100 BASE-T), CAT5E (1000 BASE-T) or CAT6 (10GBASE-T) ethernet performance in A, B or D shell housings with integrated LED's and complete shielding options we have your high-speed data requirements covered.

Features

- Class D (10/100 BASE-T), CAT5E (1000 BASE-T) or CAT6 (10GBASE-T) ethernet performance
- A, B or D type chassis housings
- IDC or IDC 110 punch down terminals
- RJ45 feedthrough panel connectors
- Shielded or non-shielded
- LED indicators in a variety of colours.
- Compact design
- Cable plug housings
- Quick and simple installation

Options

- Horizontal or Vertical PCB contacts
- Bulk Packaging
- LED colour - Red, Green, Yellow or Blue combinations

Ordering Codes

We have listed the more common ordering codes in each section. Please contact us if you need any further assistance.

Simple steps to guide you in using this catalogue

- 1) Identify the product group listed in Contents on page 1 and go directly to that page number.
- 2) Each product group cover page then details information and options available.
- 3) Refer to the product detail pages and identify the product you require pictorially.
- 4) Read the product description column for the products standard features.
- 5) Use variations column to determine your choice.
- 6) Identify part number.
- 7) In the event the particular option you require is not listed please refer to the part number breakdown page at the end of each section.
- 8) Please contact us directly if you have any further problems.



XLRNET SERIES CABLE CONNECTOR

Features/Benefits:

- XLR RJ45 Cable plug housing.
- Designed for pre-assembled RJ45 cables.
- Quick and simple installation.
- Cost effective method for harsh environments.
- No cabling in field required.
- No tools required for installation.
- Available in Nickel or Black housings.
- Coloured boots / Backshells

Specifications: Page 80

Part Number Breakdown : Page 80

Assembly Instructions: Page 81

NOTE*RJ45 preassembled cable sold separately and is not included with the XLRnet connector.

PRODUCT - FIGURE	DRAWING	Dimensions in mm (inches)	DESCRIPTION	VARIATIONS	PART NUMBER
		84 [3.31"]	XLRnet, XLR cable plug housing to suit preassembled RJ45 cables, Nickel Finish	Standard	RJX8M
				Bulk Pack	RJX8M BULK
		84 [3.31"]	XLRnet, XLR cable plug housing to suit preassembled RJ45 cables, Black Finish	Standard	RJX8MB
				Bulk Pack	RJX8MB BULK

ISO VIEW OF RJX8M

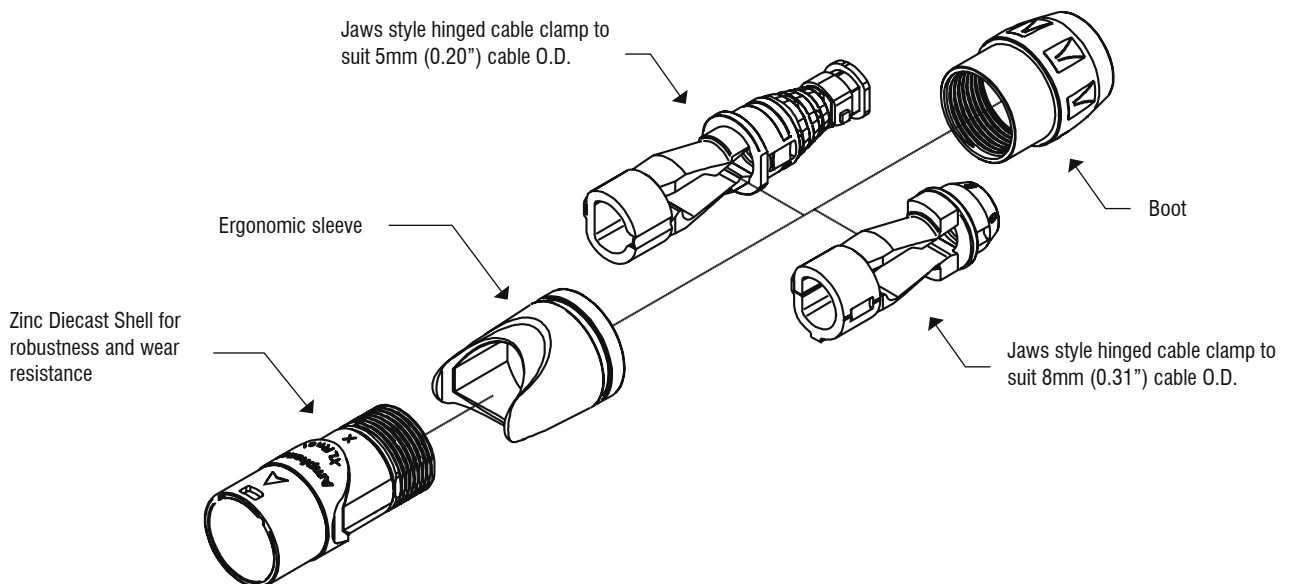

Data Connectors

XLRnet Series Cable Connector

PART NUMBER BREAKDOWN

XLRnet SERIES

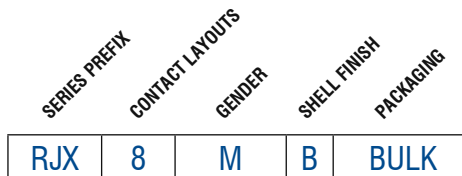

E. G. **RJX8MB BULK**
RJX (Series Prefix), **8** contacts, **M** (Cable Connector), **B** (Black Finish),
Bulk Packaged

SERIES PREFIX	RJX	=	Series Prefix
CONTACT LAYOUT	8	=	RJ45 Cable Housing
GENDER	M	=	Male Cable Plug
SHELL FINISH	Blank	=	Nickel Plated Finish
	B	=	Metal - Black Finish
PACKAGING	Blank	=	Individual Bags
	BULK	=	Bulk Packed

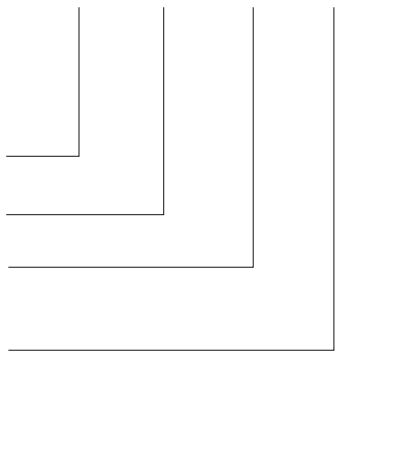

STANDARD DATA XLRnet SERIES

		VALUE
GENERAL CHARACTERISTICS	Termination	Preassembled RJ45 Cable (Not supplied)
	Environmental	Complies with EU RoHS 2 Directive 2011/65/EU
CLIMATIC CHARACTERISTICS	Protection Class	IP40
	Operating Temperature	-25°C to +75°C (-13°F to +167°F)
MECHANICAL CHARACTERISTICS	Insertion and Withdrawal force	≥ 10N - ≤ 20N
	Weight ²⁾	26g (0.057lb)
	Cable O.D. range	5 or 8mm (0.20" or 0.31")
	Mechanical Operations	1000 mating cycles
MATERIALS	Connector shell - Metal Shell finish	Diecast Zinc Alloy Satin nickel or Black
	Boot / Backshell Finish	UL94V-0 Noryl N190 / Valox Black
	Cable clamp	PA6
	Sleeve	Valox

²⁾ Approximate weight only, does not include packaging. Please contact us for exact weight for shipping purposes.

Rev 1 - 03/2013

XLRnet SERIES CABLE ASSEMBLY INSTRUCTIONS

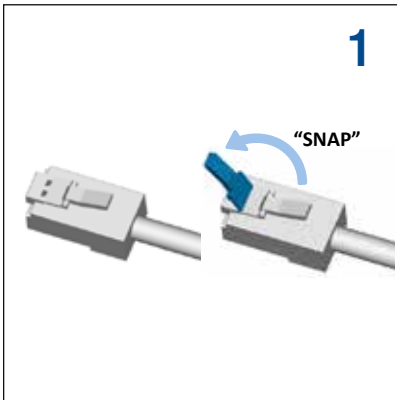

△ Snap or cut off release tab of the RJ45 plug.
Failure to remove the RJ45's Release Tab will make the XLRnet assembly permanently latching. The XLRnet series has an independent panel side latching system.

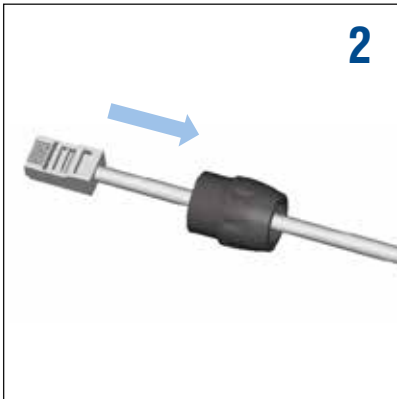

Slide the nut (backshell) onto the cable.

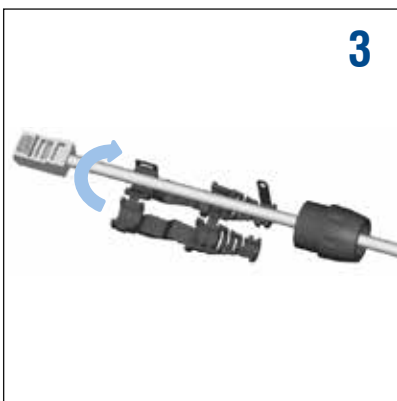

Install the cable clamp-boot.



Close clamp-boot, fasten the two tabs together to lock.



Push clamp-boot & cable together into the shell

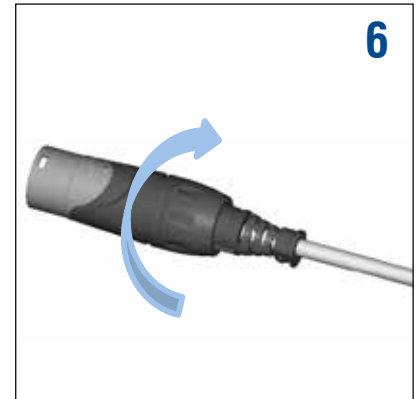

Thread the nut (backshell) onto the shell (torque 0.8Nm-1.2Nm) to close the connector assembly.

Data Connectors

XLNnet Series A & B Type Chassis Receptacles



XLRNET SERIES A & B TYPE CHASSIS RECEPTACLES

Features:

- RJ45 Class D (10/100 BASE-T), CAT5E (1000 BASE-T) or CAT6 (10GBASE-T) Ethernet performance
- A or B type chassis housings
- Shielded or non-shielded
- LED indicators in a variety of colours.
- Horizontal or Vertical PCB
- Mates with XLNnet cable plugs or standard RJ45 plug.

Part Number Breakdown: Page 84

Specifications: Page 89

PCB Footprints: Page 88







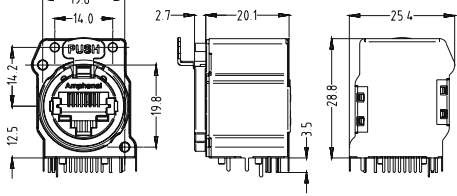

Recommended Fastener: Page 135

PRODUCT - FIGURE	DRAWING	Dimensions in mm (inches)	DESCRIPTION	TYPE	LED* LHS/RHS	PART NUMBER
		19.80, 2.7, 19.7, 24.9, 12.5, 19.80, 3.5, 28.5	XLNnet chassis, A type, Horizontal PCB	Class D	- -	RJX8FA3HB
				CAT5E		RJX8FA5HB
				CAT6		RJX8FA6HB
		19.80, 2.7, 19.7, 24.9, 12.5, 19.80, 3.5, 28.5	XLNnet chassis B type, Horizontal PCB	Class D	- -	RJX8FB3HB
				CAT5E		RJX8FB5HB
				CAT6		RJX8FB6HB
		19.80, 2.7, 19.7, 24.9, 14.0, 14.2, 12.5, 19.80, 3.5, 28.5	XLNnet chassis, B type, LEDs, Horizontal PCB, Bulk packed	CAT5E	R G R Y R R G R G Y U U	RJX8FB5HRGB RJX8FB5HRYB RJX8FB5HRRB RJX8FB5HGRB RJX8FB5HGYB RJX8FB5HUUB
				CAT6	R G R Y R R G R G Y U U	RJX8FB6HRGB RJX8FB6HRYB RJX8FB6HRRB RJX8FB6HGRB RJX8FB6HGYB RJX8FB6HUUB
		19.80, 2.7, 20.1, 25.4, 12.5, 19.80, 3.5, 28.8	XLNnet chassis, B type, Shielded Hood, Horizontal PCB, Bulk packed	Class D	- -	RJX8FB3HEB
				CAT5E		RJX8FB5HEB
				CAT6		RJX8FB6HEB

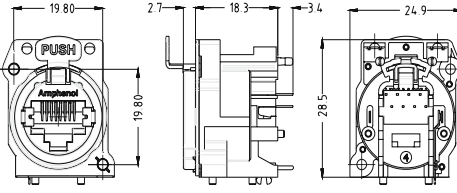
*Note: LED colours are denoted left to right from the panel side front view. Refer page 88
R = Red, G = Green, Y = Yellow, U = Blue

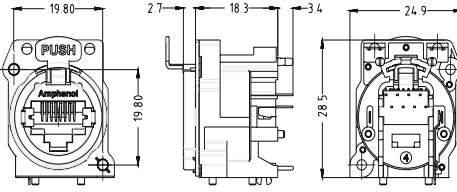
Data Connectors

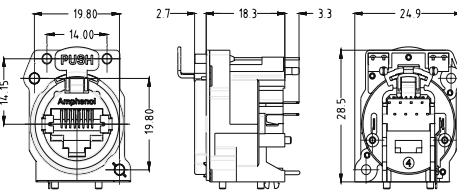
XLNnet Series A & B Type Chassis Receptacles

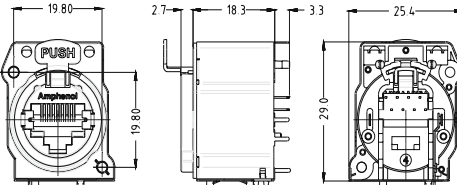
PRODUCT - FIGURE	DRAWING	Dimensions in mm (inches)	DESCRIPTION	TYPE	LED* LHS/RHS	PART NUMBER	
			XLRnet chassis, B type, Shielded Hood, LEDs, Horizontal PCB, Bulk packed	CAT5E	R G	RJX8FB5HRGEB	
					R Y	RJX8FB5HRYEB	
					R R	RJX8FB5HRRREB	
					G R	RJX8FB5HGREB	
					G Y	RJX8FB5HGYEB	
					U U	RJX8FB5HUUEB	
				CAT6	R G	RJX8FB6HRGEB	
					R Y	RJX8FB6HRYEB	
					R R	RJX8FB6HRRREB	
					G R	RJX8FB6HGREB	
					G Y	RJX8FB6HGYEB	
					U U	RJX8FB6HUUEB	
			XLRnet chassis, A type, Vertical PCB	Class D	- -	RJX8FA3VB	
					CAT5E	- -	RJX8FA5VB
						CAT6	- -
			XLRnet chassis, B Type, Vertical PCB	Class D	- -	RJX8FB3VB	
					CAT5E	- -	RJX8FB5VB
						CAT6	- -
			XLRnet chassis, B type, LEDs, Vertical PCB, Bulk packed	CAT5E	R G	RJX8FB5VRGB	
					R Y	RJX8FB5VRYB	
					R R	RJX8FB5VRRB	
					G R	RJX8FB5VGRB	
					G Y	RJX8FB5VGYB	
					U U	RJX8FB5VUUB	
				CAT6	R G	RJX8FB6VRGB	
					R Y	RJX8FB6VRYB	
					R R	RJX8FB6VRRB	
					G R	RJX8FB6VGRB	
					G Y	RJX8FB6VGYB	
					U U	RJX8FB6VUUB	
			XLRnet chassis, B type, Shielded Hood, Vertical PCB, Bulk packed	Class D	- -	RJX8FB3VEB	
					CAT5E	- -	RJX8FB5VEB
						CAT6	- -

*Note: LED colours are denoted left to right from the panel side front view. Refer page 88
R = Red, G = Green, Y = Yellow, U = Blue

Data Connectors

XLRnet Series A & B Type Chassis Receptacles

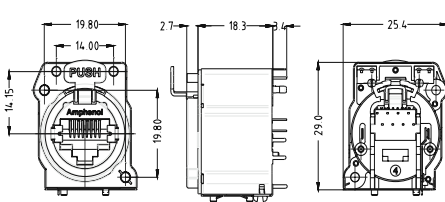
PRODUCT - FIGURE	DRAWING	DESCRIPTION	TYPE	LED* LHS/RHS	PART NUMBER
		XLRnet chassis, B type, Shielded Hood, LEDs, Vertical PCB, Bulk packed	CAT5E	R G	RJX8FB5VRGEB
				R Y	RJX8FB5VRYEB
				R R	RJX8FB5VRRREB
				G R	RJX8FB5VGRREB
				G Y	RJX8FB5VGYEB
				U U	RJX8FB5VUUEB
			CAT6	R G	RJX8FB6VRGEB
				R Y	RJX8FB6VRYEB
				R R	RJX8FB6VRRREB
				G R	RJX8FB6VGRREB
				G Y	RJX8FB6VGYEB
				U U	RJX8FB6VUUEB

*Note: LED colours are denoted left to right from the panel side front view. Refer page 88
 R = Red, G = Green, Y = Yellow, U = Blue

PART NUMBER BREAKDOWN

XLRnet A and B Type Printed Circuit Board Connectors

E. G. **RJX8FB5HLRREB**
RJX (Series Prefix), **8** (Contacts), **Female B** type, **5** Cat5E **Horizontal**, **Latchless**,
Red - Red LEDs, **EMI / RFI Hood**, **Bulk** Packaged.

SERIES PREFIX
 CONTACT LAYOUTS
 GENDER
 SHELL SERIES
 TRANSMISSION CLASS
 TERMINATION
 LOCKING MECHANISM
 LED COLOURS
 EMI / RFI HOOD
 PACKAGING

RJX	8	F	B	5	H	L	RR	E	B
-----	---	---	---	---	---	---	----	---	---

SERIES PREFIX	RJX	=	Series Prefix
CONTACT LAYOUT	8	=	RJ45 type
GENDER	F	=	Receptacle housing
SHELL SERIES	A	=	A Type
	B	=	B Type
TRANSMISSION CLASS	3	=	Class D
	5	=	CAT 5e
	6	=	CAT 6
TERMINATION	H	=	Horizontal Printed Circuit Board
	V	=	Vertical Printed Circuit Board
LOCKING MECHANISM	Blank	=	Latching
	P	=	Push lever supplied separately for customer installation (Contact factory for detailed fitting instructions)
LED COLOUR SEQUENCE*	Blank	=	No LEDs
	RG	=	Red / Green
	RY	=	Red / Yellow
	RR	=	Red / Red
	GR	=	Green / Red
	GY	=	Green / Yellow
	GG	=	Green / Green
	YR	=	Yellow / Red
	YY	=	Yellow / Yellow
	YG	=	Yellow / Green
	UU	=	Blue / Blue
EMI / RFI SHIELDING HOOD	Blank	=	No shield hood
	E	=	EMI / RFI shield hood
PACKAGING	Blank	=	Individual
	B	=	Bulk packed

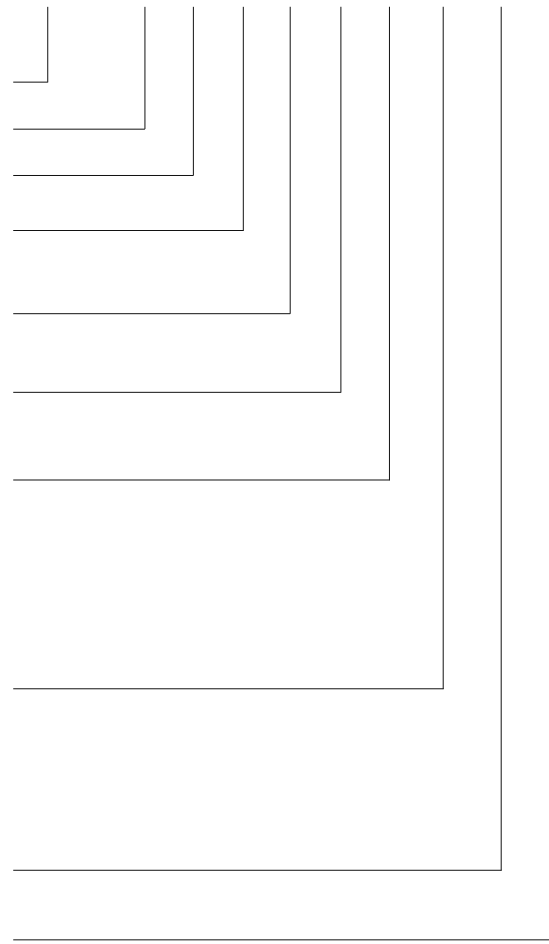

*Note: LED colours are denoted left to right from the panel side front view.
 Refer Page 88



XLRNET SERIES D TYPE CHASSIS RECEPTACLES

Features:

- RJ45 Class D (10/100 Base-T), CAT5E (1000 Base-T) or CAT6 (10GBASE-T) Ethernet performance
- D type XLR standard housings
- IDC Punchdown block
- Thru-adaptor / Feedthrough
- Horizontal or Vertical PCB

Part Number Breakdown: Page 87

Specifications: Page 89

PCB Footprints: Page 88

Recommended Fastener: Page 135

PRODUCT - FIGURE	DRAWING	Dimensions in mm (inches)	DESCRIPTION	TYPE	PART NUMBER
			XLNnet chassis, D type, Feedthrough, Nickel Finish	CAT5E	RJX8FD5T
			XLNnet chassis, D type, IDC Terminals, 110 type, Nickel Finish	CAT5E	RJX8FD5110
			XLNnet chassis, D type, IDC Terminals, 110 type, Nickel Finish	CAT6	RJX8FD6110
			XLNnet chassis, D type, IDC Terminals, Nickel Finish	CAT5E	RJX8FD5I
			XLNnet chassis, D type, IDC Terminals, Nickel Finish	CAT6	RJX8FD6I
			XLNnet chassis, D type, Horizontal PCB, Nickel Finish	Class D	RJX8FD3HB
			XLNnet chassis, D type, Horizontal PCB, Nickel Finish	CAT5E	RJX8FD5HB
			XLNnet chassis, D type, Horizontal PCB, Nickel Finish	CAT6	RJX8FD6HB
			XLNnet chassis, D type, Vertical PCB, Nickel Finish	Class D	RJX8FD3VB
			XLNnet chassis, D type, Vertical PCB, Nickel Finish	CAT5E	RJX8FD5VB
			XLNnet chassis, D type, Vertical PCB, Nickel Finish	CAT6	RJX8FD6VB

Data Connectors

XLRnet Series D Type Chassis Receptacles

PRODUCT - FIGURE	DRAWING	Dimensions in mm (inches)	DESCRIPTION	TYPE	PART NUMBER
			XLRnet chassis, D type (IP54), Feedthrough, Nickel Finish	CAT5E	RJXS8FD5T
			XLRnet chassis, D type (IP54), IDC Terminals, 110 type, Nickel Finish	CAT5E	RJXS8FD5110
				CAT6	RJXS8FD6110
			XLRnet chassis, D type (IP54), IDC Terminals, Nickel Finish	CAT5E	RJXS8FD5I
				CAT6	RJXS8FD6I
			XLRnet chassis, D type (IP54), Horizontal PCB, Nickel Finish	Class D	RJXS8FD3HB
				CAT5E	RJXS8FD5HB
				CAT6	RJXS8FD6HB
			XLRnet chassis, D type (IP54), Vertical PCB, Nickel Finish	Class D	RJXS8FD3VB
				CAT5E	RJXS8FD5VB
				CAT6	RJXS8FD6VB
			XLRnet chassis with Protective cap, D type (IP54), Feedthrough, Nickel Finish	CAT5E	RJXS8FG5T
			XLRnet chassis with Protective cap, D type (IP54), IDC Terminals, 110 type, Nickel Finish	CAT5E	RJXS8FG5110
				CAT6	RJXS8FG6110
			XLRnet chassis with Protective cap, D type (IP54), IDC Terminals, Nickel Finish	CAT5E	RJXS8FG5I
				CAT6	RJXS8FG6I
			XLRnet chassis with Protective cap, D type (IP54), Horizontal PCB, Nickel Finish	Class D	RJXS8FG3HB
				CAT5E	RJXS8FG5HB
				CAT6	RJXS8FG6HB
			XLRnet chassis with Protective cap, D type (IP54), Vertical PCB, Nickel Finish	Class D	RJXS8FG3VB
				CAT5E	RJXS8FG5VB
				CAT6	RJXS8FG6VB

PART NUMBER BREAKDOWN

XLRnet D TYPE Chassis Connectors

E. G. **RJX8FD3TB**
RJX (Series Prefix), **8** (Contacts), **F**emale **D** type, **3** Class **D** Thru Adaptor, **B**ulk Packaged

SERIES PREFIX	RJX	=	Series Prefix
CONTACT LAYOUT	8	=	RJ45 type
GENDER	F	=	Receptacle housing
SHELL SERIES	D	=	D Type
TRANSMISSION CLASS	3	=	Class D
	5	=	CAT 5e
	6	=	CAT 6
TERMINATION	H	=	Horizontal Printed Circuit Board
	I	=	IDC Punch Down Block
	110	=	IDC 110 Punch Down Block
	T	=	Thru adaptor / Feedthrough
	V	=	Vertical Printed Circuit Board
LOCKING MECHANISM	Blank	=	Latching
	P	=	Push lever supplied separately for customer installation (Contact factory for detailed fitting instructions)
PACKAGING	Blank	=	Individual
	B	=	Bulk packed

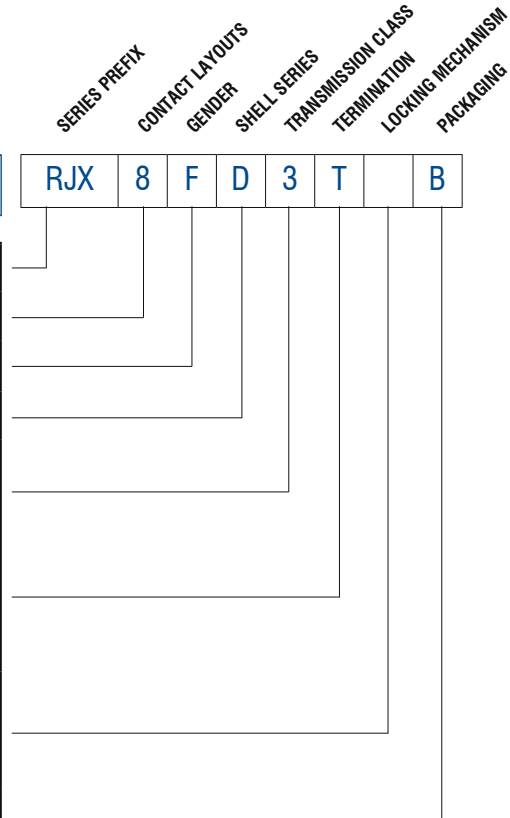

*Note: LED colours are denoted left to right from the panel side front view. Refer Page 88

STANDARD DATA XLRnet CHASSIS RECEPTACLES

		VALUE		
		Class D	CAT5E	CAT6
GENERAL CHARACTERISTICS	Number of contacts	8		
	Contact Arrangement	RJ45		
	Termination	Printed Circuit Board (PCB) - through hole, Feedthrough, IDC Terminal		
	Flammability	UL94V-0		
	Environmental	Complies with EU RoHS 2 Directive 2011/65/EU		
	Solderability	MIL-STD 202, Method 208		
ELECTRICAL CHARACTERISTICS	Rated current per contact	1.5 A		
	Rated Voltage	125V AC		
	Typical Contact Resistance	20mΩ		
	Insulation Resistance	> 500MΩ		
	Dielectric Strength	1000 VAC, 60 secs		
	Max. Frequency	100Mhz	100MHz	250MHz
	Ethernet Standard	10/100 BASE-T	1000 BASE-T	10GBASE-T
	Transmission Spec.	EIA/ TIA568-C.2, ISO/IEC 11801, EN50173		
	PoE+	802.3at Type 2		
	LED Type	Round, single pole, indicator		
CLIMATIC CHARACTERISTICS	Protection Class	IP40 (with EMI/RFI shield)		
	Operating Temperature	-40°C to +80°C (-40°F to +176°F)		
MECHANICAL CHARACTERISTICS	Weight** - A & B Housing - Shielded Housing - D Shell	11g (0.024lb) 17g (0.037lb) 25g (0.055lb)		
	Mechanical Operations	1000		
	Insertion and Withdrawal Force	≤ 21N		
	Latch	Spring Steel		
	Panel Thickness max.	3mm		
	Mounting screw torque max.	0.35Nm		
	Fastener	Self-Tapping screw M2.5		
	MATERIALS	Connector Shell / Housing	Thermoplastic, DSM Stanyl UL94V-0, 30% GF / PA66 30% GF	
Flange (A type)		Thermoplastic, DSM Stanyl UL94V-0, 30% GF		
Flange (B type)		Diecast Zinc Alloy 3		
Flange Finish (B type)		Satin Nickel		
Contact		Phosphor Bronze		
Contact Finish - Ground - RJ45		0.38μm Au over 1.27μm Ni 1.27μm Au over 1.27μm Ni		
Metal Hood Shield EMI/RFI		Brass, nickel plated		
Latch lock and Spring		Spring steel		

Rev 4 - 11/2021

**Approximate weight in grams not including packaging. Please contact us for exact weight for shipping purposes.

Data Connectors

USB/HDMI Series



USB/HDMI SERIES

Features:

- Data connectors
- Feedthrough adaptors
- USB 3 Type A
- HDMI receptacles

Options: Nickel or Black Shell Finish

PRODUCT - FIGURE	DRAWING	Dimensions in mm (inches)	DESCRIPTION	VARIATIONS	PART NUMBER
	<p>FRONT VIEW</p> <p>REAR VIEW</p>	<p>Dimensions in mm (inches)</p>	USB 3.0, Feedthrough adapter, D Flange, Nickel Finish	Type A / Type A	AC-USB3-AA
			USB 3.0, Feedthrough adapter, D Flange, Black Finish	Type A / Type A	AC-USB3-AAB
			HDMI, Feedthrough adapter, D Flange, Nickel Finish	HDMI / HDMI	AC-HDMI-RR
			HDMI, Feedthrough adapter, D Flange, Black Finish	HDMI / HDMI	AC-HDMI-RRB

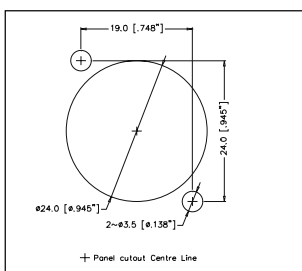

PANEL CUTOUT DIMENSIONS

FRONT VIEW

AC-****

USB/HDMI TECHNICAL DATA

		VALUE	
GENERAL CHARACTERISTICS	Type	USB 3.0	HDMI 2.0
	Termination	Thru-adaptor	
	Max. Wire Gauge - Stranded Wire	AWG 14 - 2.5mm ²	
	Flammability rating of insulating plastics	UL94V-0	
	Solderability, complies with	IEC 68-2-20	
	Environmental	Complies with EU RoHS 2 Directive 2011/65/EU	
ELECTRICAL CHARACTERISTICS	Current Carrying Capacity	10A (Depends on Mating Connector)	
	Typical Contact Resistance	≤10mΩ (Depends on Mating Connector)	
	Insulation resistance (initial)	>2GΩ	
	After Damp Heat Test	≥ 10 ⁹ Meg Ω	
Dielectric Strength	1500 V dc		
CLIMATIC CHARACTERISTICS	Protection Class	IP40	
	Operating Temperature	-25°C to +75°C (-13°F to +167°F)	
MECHANICAL CHARACTERISTICS	Insertion and Withdrawal Force	≥10N - ≤30N (depends on mating connector)	
	Cable O.D.	3mm to 7mm (0.118" to 0.275")	
	Mechanical Operations	1000 mating cycles	
	Weight - Cable Mount - Panel Mount	18g (0.039lb) 30g (0.066lb)	
MATERIALS	Connector Shell Material (Plugs)	Diecast Zinc Alloy EZDA No.3	
	Connector Shell Finish	Satin Nickel or Coloured Polyester	
	Insulators	PA66	
	Cable Bushing	Thermoplastic Polyurethane	
	Contacts	Brass Alloy	
	Plating	Gold Flash	

Rev 2 - 03/2021

¹⁾ Approximate weight only, does not include packaging. Please contact us for exact weight for shipping purposes.



1/4" PHONE CONNECTORS

Amphenol offers two ranges of 1/4" Phone plug connectors to satisfy the needs of the manufacturer and the end user. The PRO – a heavy duty on-road plug and the MUSICIAN - a solid performing general use plug. Both series offer different features and benefits and the most suitable type will be determined by application, budget and personal choice.

Applications

- Audio Cables and Snakes
- Amplifiers
- Mixing desks
- Patch panel

PRO RANGE 1/4" Phone Plug T-Series

Features / Options

- Mono or Stereo (TRS)
- Switching Plugs
- Nickel or Gold contact plating
- Straight or Right Angle
- Optional heavy duty metal backshell / boot
- Increased solder area on ground contact
- "Jaws" Cable Clamp
- Precision machined contacts
- Coloured Grommet
- JUMBO Series Plugs

PRO RANGE 1/4" Phone Plug Q-Series

Features / Options

- Mono or Stereo (TRS)
- Slimline design
- Quick and Easy to assemble
- Nickel or Gold contact plating
- Chuck style cable clamp
- Nickel or Black shell finish
- Molded backshell

MUSICIAN RANGE 1/4" Phone Plug

Features / Options

- Mono or Stereo (TRS)
- Compact Shell
- Straight or Right angle
- Flexible grommet cable protection
- Nickel or Gold contact plating
- Satin Nickel or Black finish
- Coloured Grommet

Jaws Cable Clamp Options for T-Series*



Standard Jaws cable clamp (Black), Cable O.D 3mm to 6mm (0.118" to 0.236")



Large Jaws cable clamp (Purple), Cable O.D 6mm to 7mm (0.236" to 0.275")

*Note: Applicable to T-Series straight cable connectors only. Refer to page 102 for right angle connector Jaws cable clamp specifications.

Chuck Clamp for Q-Series



Standard Chuck clamp (Black), Cable O.D 3mm to 7mm (0.118" to 0.275")

Musician Range Cable Clamp Options



M-Series, Cable O.D 3mm to 6.5mm (0.118" to 0.256")



M-Series II, Cable O.D 6.5mm to 8mm (0.256" to 0.315")

Ordering Codes

We have listed the more common ordering codes in each section. Refer to our 1/4" plug product feature matrix found on the next page for assistance on selecting the right plug for your application.

Simple steps to guide you in using this catalogue

- 1) Identify the product group listed in Contents on page 1 and go directly to that page number.
- 2) Each product group cover page then details information and options available.
- 3) Refer to the product detail pages and identify the product you require pictorially.
- 4) Read the product description column for the products standard features.
- 5) Use variations column to determine your choice.
- 6) Identify part number.
- 7) In the event the particular option you require is not listed please refer to the part number breakdown page at the end of each section.
- 8) Please contact us directly if you have any further problems.

1/4" PLUG FEATURE MATRIX

FEATURES		T SERIES (STRAIGHT)	T SERIES (RIGHT ANGLE)	JUMBO T SERIES	SWITCHPLUG T SERIES (STRAIGHT)	SWITCHPLUG T SERIES (RIGHT ANGLE)	Q SERIES	M SERIES	M SERIES II	CUSTOM SERIES ¹
PRECISION MACHINED CONTACTS		X	X	X	X	X	X	X	X	X
CENTER CONTACT	1 pc. Center Contact	X	X	X	X	X				X*
	2 pc Press Fit Tip/Center Contact						X	X	X	X*
BARREL:	Machined Tube	X	X	X	X	X				
	Precision Extruded Tube						X	X	X	X
JAWS CABLE CLAMP		X	X		X	X				
MIN. CABLE OD	Black Jaw: 3mm/0.118"	X	X		X	X				
	Purple Jaw: 6mm/0.236"	X			X					
	Purple Jaw: 5.5mm/0.216"		X			X				
MAX. CABLE OD	Black Jaw: 6mm/0.236"	X			X					
	Black Jaw: 5.5mm/0.216"		X			X				
	Purple Jaw: 7.5mm/0.295"	X			X					
	Purple Jaw: 6.5mm/0.255"		X			X				
CHUCK CABLE CLAMP										
MIN. CABLE OD	Black Chuck: 3.5mm/0.137"						X			
MAX. CABLE OD	Black Jaw: 7mm/0.275"						X			
STANDARD CABLE CLAMP				X				X	X	X
MIN. CABLE OD	7.5mm/0.295"			X						
MAX. CABLE OD	6mm/0.236"							X		
	8mm/0.315"								X	
	8.8mm/0.345"									X
	10.5mm/0.413"			X						
BACKSHELL FINISH	Satin Nickel	X	X	X	X	X	X	X	X	
	Black	X	X	X	X	X	X	X	X	
	Bright Nickel									X
	Bright Gold									X
CONTACT MATERIAL/ FINISH OPTIONS	Brass/Nickel (Ni)	X	X	X	X	X	X	X	X	X
	Brass/Gold over 2µm (Ni)	X	X	X	X	X	X	X	X	X

¹Custom Series - Minimum order quantities apply. Contact us for further details.

Plugs & Jacks

T Series Plugs



T SERIES PLUGS

Features:

- Mono or Stereo (TRS).
- Stylised shell design with Ergonomic grip.
- Straight or Right Angle.
- Robust diecast shell in Satin nickel or Black finish.
- Nickel or Gold contact plating.
- Keyed shell.
- Optional heavy duty metal backshell / boot.
- Great solderability.
- Increased solder area on ground contact.
- "Jaws" Cable Clamp.
- Precision machined contacts.
- Quick and easy assembly.







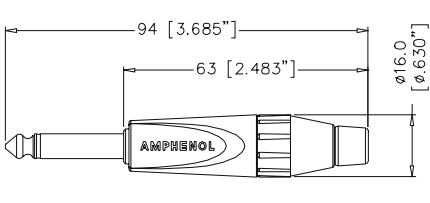

Options: Gold Contacts, Large or Small Jaws Cable Clamp, Black Shell, Metal Backshell / Boot, Bulk Pack. Coloured grommets (ordered separately)

Part Number Breakdown: Page 97 **Specifications:** Page 98

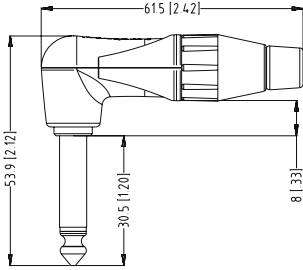
PRODUCT - FIGURE	DRAWING	DESCRIPTION	VARIATIONS	PART NUMBER
		1/4" (6.35mmø) Mono Phone plug, Jaws cable clamp, Thermoplastic back-shell, Satin finish.	Standard	TM2P
			Gold Plated Contacts	TM2P-AU
			Large Cable Clamp	TM2PJ
			Bulk Pack	TM2P BULK
		1/4" (6.35mmø) Mono Phone plug, Jaws cable clamp, Thermoplastic back-shell, Black finish.	Standard	TM2PB
			Gold Plated Contacts	TM2PB-AU
			Large Cable Clamp	TM2PBJ
			Bulk Pack	TM2PB BULK
		1/4" (6.35mmø) Stereo Phone plug, Jaws cable clamp, Thermoplastic back-shell, Satin finish.	Standard	TS3P
			Gold Plated Contacts	TS3P-AU
			Large Cable Clamp	TS3PJ
			Bulk Pack	TS3P BULK
		1/4" (6.35mmø) Stereo Phone plug, Jaws cable clamp, Thermoplastic back-shell, Black finish.	Standard	TS3PB
			Gold Plated Contacts	TS3PB-AU
			Large Cable Clamp	TS3PBJ
			Bulk Pack	TS3PB BULK

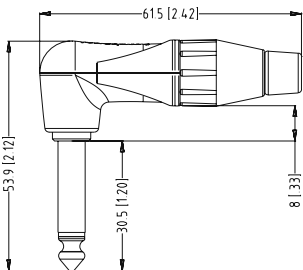
Plugs & Jacks

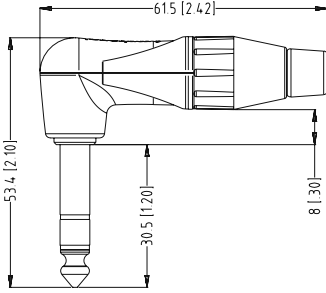
T Series Plugs

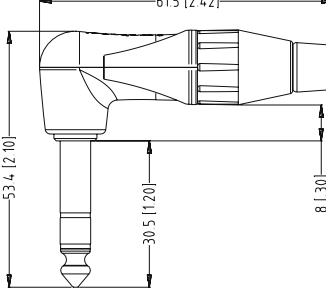
PRODUCT - FIGURE	DRAWING	DESCRIPTION	VARIATIONS	PART NUMBER
		1/4" (6.35mmø) Mono Phone plug, Jaws cable clamp, Metal backshell, Satin finish.	Standard	TM2PN
			Gold Plated Contacts	TM2PN-AU
			Large Cable Clamp	TM2PNJ
			Bulk Pack	TM2PN BULK
		1/4" (6.35mmø) Mono Phone plug, Right angle, Jaws cable clamp*, Thermoplastic backshell, Satin finish.	Standard	TM2RJ
			Gold Plated Contacts	TM2RJ-AU
		1/4" (6.35mmø) Mono Phone plug, Right angle, Jaws cable clamp*, Thermoplastic backshell, Black finish.	Standard	TM2RBJ
			Gold Plated Contacts	TM2RBJ-AU
			Bulk Pack	TM2RBJ BULK
		1/4" (6.35mmø) Stereo Phone plug, Right angle, Jaws cable clamp*, Thermoplastic backshell, Satin finish.	Standard	TS3RJ
			Gold Plated Contacts	TS3RJ-AU
		1/4" (6.35mmø) Stereo Phone plug, Right angle, Jaws cable clamp*, Thermoplastic backshell, Black finish.	Standard	TS3RBJ
			Gold Plated Contacts	TS3RBJ-AU

*NOTE: Refer to page 102 for Jaws cable clamp specifications applicable to right angle connectors.

Plugs & Jacks

T Series (Jumbo) Plugs



T SERIES (JUMBO) PLUGS

Features:

- JUMBO Cable clamping capacity
- Suits Cable OD 7.5mm (0.295") to 10.5mm (0.413")
- Mono or Stereo (TRS).
- Stylised shell design with Ergonomic grip.
- Robust diecast shell in Satin nickel or Black finish.
- Nickel or Gold contact plating.
- Keyed shell.
- Great solderability.
- Increased solder area on ground contact.
- Precision machined contacts.
- Quick and easy assembly.

Options: Gold Contacts, Bulk Pack

Specifications: Page 102

PRODUCT - FIGURE	DRAWING	Dimensions in mm (inches)	DESCRIPTION	VARIATIONS	PART NUMBER
			1/4" (6.35mm \varnothing) JUMBO Mono Phone plug, Thermoplastic back-shell, Satin finish.	Standard	JM2P
				Gold Plated Contacts	JM2P-AU
				Bulk Pack	JM2P BULK
			1/4" (6.35mm \varnothing) JUMBO Mono Phone plug, Thermoplastic back-shell, Black finish.	Standard	JM2PB
				Gold Plated Contacts	JM2PB-AU
			1/4" (6.35mm \varnothing) JUMBO Stereo Phone plug, Thermoplastic back-shell, Satin finish.	Standard	JS3P
				Gold Plated Contacts	JS3P-AU
			1/4" (6.35mm \varnothing) JUMBO Stereo Phone plug, Thermoplastic back-shell, Black finish.	Standard	JS3PB
				Gold Plated Contacts	JS3PB-AU

NOTE: Contact factory for availability of metal backshells.

PART NUMBER BREAKDOWN

T-SERIES (PRO RANGE)

E. G . **TS3PBMJ-AU BULK**
T (Series Prefix), **S3**(Stereo), **P**lug **B**lack, **M**etal Nut (Black), **J** (Large Jaws),
- AU (Gold Plated Contacts), **Bulk** Packaged.

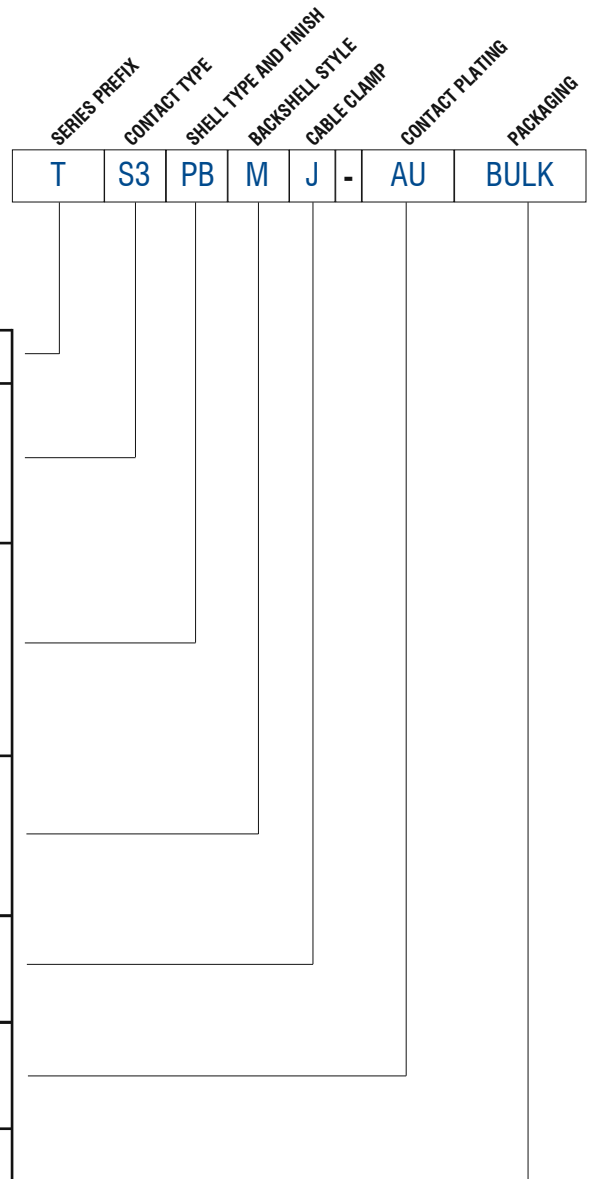

SERIES PREFIX	T	=	Series Prefix
CONTACT TYPE	M1	=	Switch Plug
	M2	=	2 Pole (mono)
	S3	=	3 Pole, tip/ring/sleeve (stereo)
SHELL TYPE AND FINISH	P	=	Plug Satin Nickel
	PB	=	Plug Matt Black
	R	=	Right Angle Plug Satin Nickel
	RB	=	Right Angle Plug Matt Black
BACKSHELL TYPE	Blank	=	Plastic Nut
	M	=	Metal Nut - Black
	N	=	Metal Nut - Satin Nickel
CABLE CLAMP	Blank	=	Small Jaws
	J	=	Large Jaws
CONTACT PLATING	Blank	=	Nickel Plated Contacts (Standard)
	AU	=	Gold Plated Contacts
PACKAGING	Blank	=	Individual Bags
	BULK	=	Bulk Packed

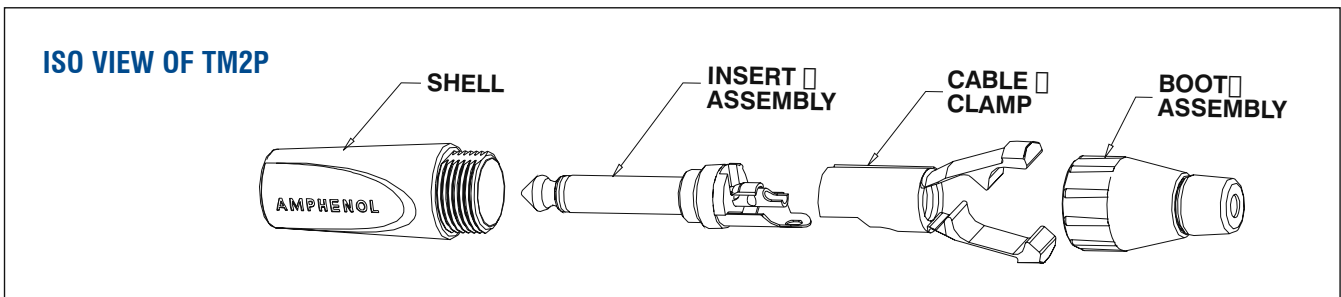

Plugs & Jacks

T-Series SwitchPlug



T-SERIES SWITCHPLUG

The Amphenol T series SwitchPlug uses a unique 360 degree precision sliding helical spring contact design to quietly and accurately switch the signal circuit safely to ground during instrument changes under load, thereby avoiding annoying thumps, pops and squeals. The sliding ring contact self-cleans every time the plug is connected preventing excessive build up of oxidization and contamination. Activation is directly off the jacks full front face assuring a positive reference point every time, and as it works instantaneously on the main circuits there is no need for the use of magnets or other elaborate switching mechanisms.

WARNING!
For use with
instrument (guitar)
applications only.

Part Number Breakdown: Page 97
Specifications: Page 102

PRODUCT - FIGURE	DRAWING	Dimensions in mm (inches)	DESCRIPTION	VARIATIONS	PART NUMBER
			1/4" (6.35mm \varnothing) Switch Phone plug, Jaws cable clamp, Thermoplastic backshell, Satin finish	Standard Gold Plated Contacts Large Cable Clamp	TM1P TM1P-AU TM1PJ
			1/4" (6.35mm \varnothing) Switch Phone plug, Jaws cable clamp, Thermoplastic backshell, Black finish	Standard Gold Plated Contacts Large Cable Clamp	TM1PB TM1PB-AU TM1PBJ
			1/4" (6.35mm \varnothing) Switch Phone plug, Right angle, Jaws cable clamp*, Thermoplastic backshell, Satin Finish	Standard Gold Plated Contacts	TM1RJ* TM1RJ-AU*
			1/4" (6.35mm \varnothing) Switch Phone plug, Right angle, Jaws cable clamp*, Thermoplastic backshell, Black Finish	Standard Gold Plated Contacts	TM1RBJ* TM1RBJ-AU*

*NOTE: Refer to page Page 102 for Jaws cable clamp specifications applicable to right angle connectors.

SwitchPlug - User Instruction

CAUTION! Use with instrument (guitar) cables only.
DO NOT connect to amplifier output.
Equipment damage may result from incorrect use.

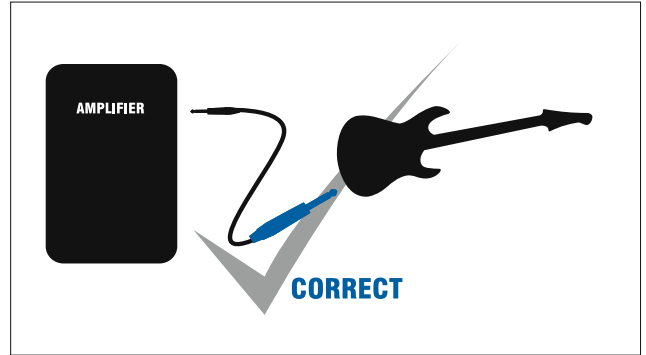
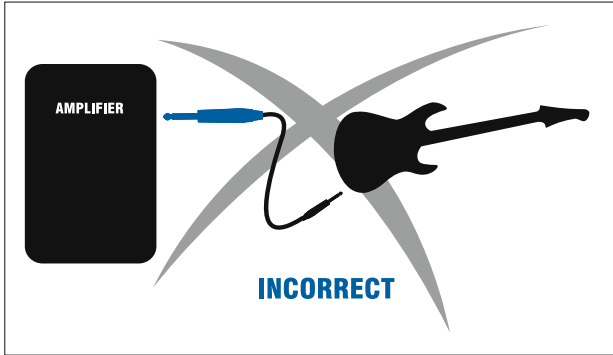

SwitchPlug - Technology*

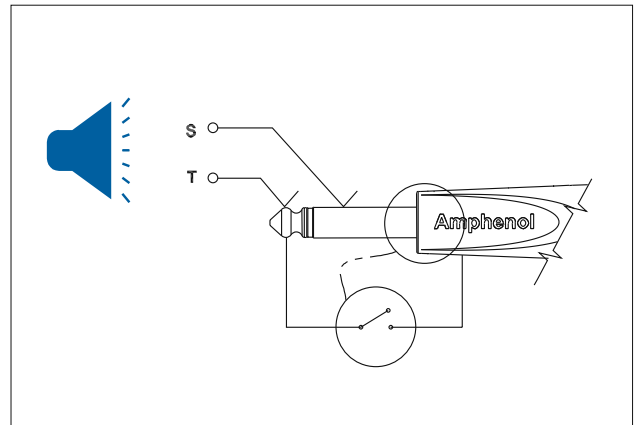
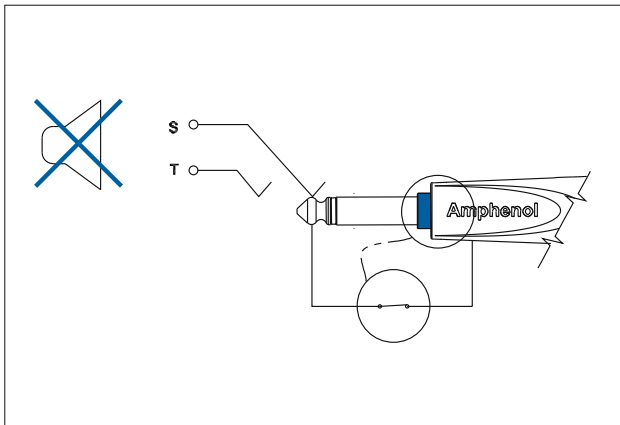

*US Patent No. 8,162,697

Plugs & Jacks

Q Series Plugs



Q SERIES PLUGS

Features:

- Mono or Stereo (TRS)
- Slimline design
- Quick and Easy to assemble
- Nickel or Gold contact plating
- Chuck style cable clamp
- Nickel or Black shell finish
- Molded backshell

Clamp Info:



Standard Chuck clamp (Black), Cable O.D 3mm to 7mm (0.118" to 0.275")





Options: Gold Plated Contacts, Black Shell, Bulk Pack.

Specifications: Page 102

PRODUCT - FIGURE	DRAWING	Dimensions in mm (inches)	DESCRIPTION	VARIATIONS	PART NUMBER
			1/4" (6.35mmø) Mono Phone plug, Chuck cable clamp, Molded boot, Satin Finish	Standard	QM2P
			1/4" (6.35mmø) Mono Phone plug, Chuck cable clamp, Molded boot, Black Finish	Gold Plated Contacts	QM2PB-AU
			1/4" (6.35mmø) Stereo Phone plug, Chuck cable clamp, Molded boot, Satin Finish	Standard	QS3P
			1/4" (6.35mmø) Stereo Phone plug, Chuck cable clamp, Molded boot, Black Finish	Gold Plated Contacts	QS3PB-AU

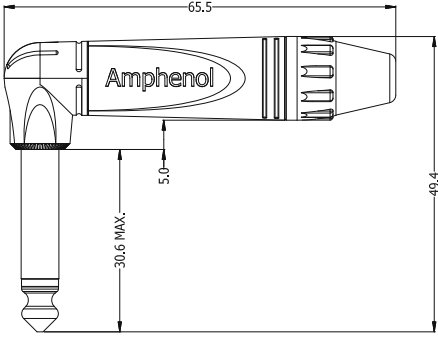
Plugs & Jacks

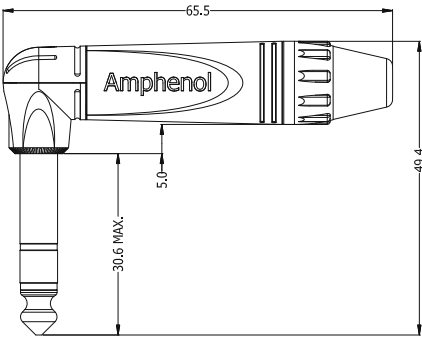
Q Series Plugs

PRODUCT - FIGURE	DRAWING	DESCRIPTION	VARIATIONS	PART NUMBER
		1/4" (6.35mmø) Mono Phone plug, Right angle Chuck cable clamp, Molded boot, Satin Finish	Standard	QM2R
		1/4" (6.35mmø) Mono Phone plug, Right angle Chuck cable clamp, Molded boot, Black Finish	Gold Plated Contacts	QM2RB-AU
		1/4" (6.35mmø) Stereo Phone plug, Right angle Chuck cable clamp, Molded boot, Satin Finish	Standard	QS3R
		1/4" (6.35mmø) Stereo Phone plug, Right angle Chuck cable clamp, Molded boot, Black Finish	Gold Plated Contacts	QS3RB-AU

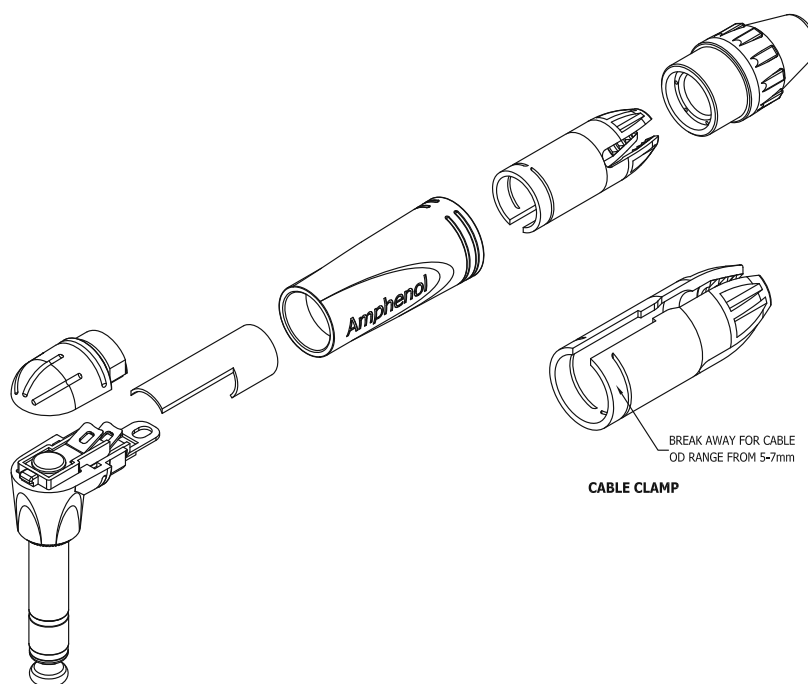

Plugs & Jacks

Q Series Plugs

1/4" PHONE PLUG TECHNICAL DATA

		VALUE			
		Straight	Right Angle	Jumbo	
GENERAL CHARACTERISTICS	Number of Contacts	3 Pole Tip Ring Sleeve (Stereo)			
	Termination	Solder			
	Max. Wire Gauge - Stranded Wire	2 Pole (Mono): AWG 16 - 1.5mm 3 Pole (Stereo): AWG 18 - 1mm			
	Flammability rating of insulating plastics	UL94V-0			
	Solderability, complies with	IEC 68-2-20			
	Environmental	Complies with EU RoHS 2 Directive 2011/65/EU			
ELECTRICAL CHARACTERISTICS	Current Carrying Capacity	10A (Depends on Mating Connector and Cable)			
	Typical Contact Resistance	Depends on Mating Connector			
	Insulation Resistance (initial)	>2GΩ			
	After Damp Heat Test	≥1GΩ			
	Dielectric Withstand Voltage	2 Pole : 1.5 kV dc 3 Pole : 1 kV dc			
CLIMATIC CHARACTERISTICS	Protection Class	IP40			
	Operating Temperature	-25°C to +75°C (-13°F to + 167°F)			
MECHANICAL CHARACTERISTICS	Insertion and Withdrawal Force	≥10N - ≤30N			
	Weight ¹	Thermoplastic Backshell	28g (0.061lb)		
		Metal Backshell	35g (0.077lb)		
	Typical Cable Retention Force	22kg to 44kg (50lb to 100lb) - Dependent on cable material and diameter.			
	Cable O.D.	Standard Jaw (T-Series)	3mm to 6mm (0.118" to 0.236")	3mm to 5.5mm (0.118" to 0.216")	N/A
		Large Jaw (T-Series)	6mm to 7mm (0.236" to 0.275")	5.5mm to 6.5mm (0.216" to 0.255")	N/A
		Standard Clamp (Q-Series)	3.5mm to 7mm (0.137" to 0.275")	N/A	N/A
		Jumbo	NA	NA	7.5mm to 10.5mm (0.295" to 0.413")
Mechanical Operations	1000				
MATERIALS	Connector Shell Material	Diecast Zinc Alloy EZDA No.3			
	Shell Finish	Satin Nickel or Black Polyester			
	Insulators	UL94 V-0 PBT Resin or Modified PPE Resin - Black			
	Boot / Backshell	UL94 V-0 PBT Resin or Modified PPE Resin - Black or Metal CuZn ³⁹ Pb ³			
	Cable Clamp	UL94 V-0 PBT Modified PPO Resin - Black			
	Cable Bushing	Santoprene			
	Contacts / Plating	Brass/Ni or Au over 2μm Ni			

Rev 6 - 10/2017

¹ Approximate weight only, does not include packaging. Please contact us for exact weight for shipping purposes.



MUSICIAN SERIES II PLUGS

Features:

- Mono or Stereo (TRS).
- AX Series inspired shell design.
- Large cable O.D. Entry to 8mm (0.315")
- Robust diecast shell in Satin nickel or Black finish.
- Nickel or Gold contact plating.
- Flexible grommet cable protection.
- Improved solderability.
- Precision machined contacts.
- Standard or Bulk packaging.

Clamp Info:



Cable O.D 6.5mm to 8mm (0.256" to 0.315")

Options: Black Shell, Gold contacts.
 Coloured grommets (ordered separately)







Specifications: Page 112

PRODUCT	DRAWING Dimensions in mm (inches)	DESCRIPTION	VARIATIONS	PART NO.
		1/4" (6.35mm \emptyset) Mono Phone plug, Diecast Shell, Satin finish, Flexible grommet.	Standard	ACPM-KN
			Gold Plated Contacts	ACPM-KN-AU
		1/4" (6.35mm \emptyset) Mono Phone plug, Diecast Shell, Black finish, Flexible grommet.	Standard	ACPM-KB
			Gold Plated Contacts	ACPM-KB-AU
		1/4" (6.35mm \emptyset) Stereo Phone plug, Diecast Shell, Satin finish, Flexible grommet.	Standard	ACPS-KN
			Gold Plated Contacts	ACPS-KN-AU
		1/4" (6.35mm \emptyset) Stereo Phone plug, Diecast Shell, Black finish, Flexible grommet.	Standard	ACPS-KB
			Gold Plated Contacts	ACPS-KB-AU

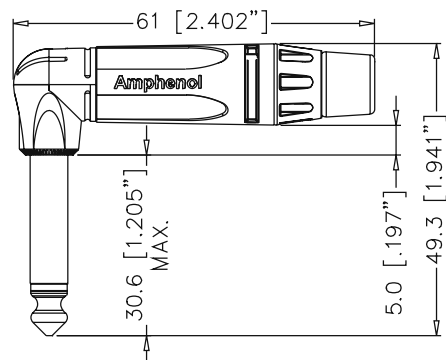
*NOTE: Refer to page 103 for Jaws cable clamp specifications applicable to right angle connectors.

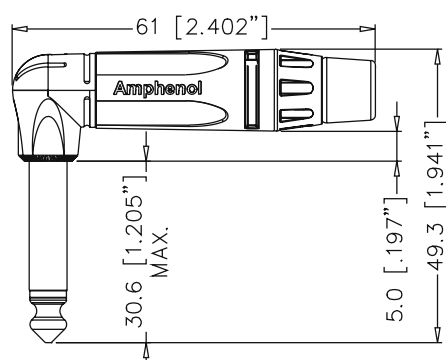
Plugs & Jacks

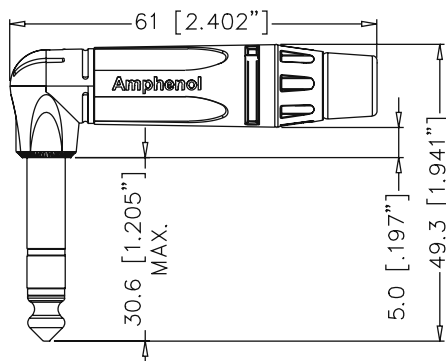
Musician Series II Plugs

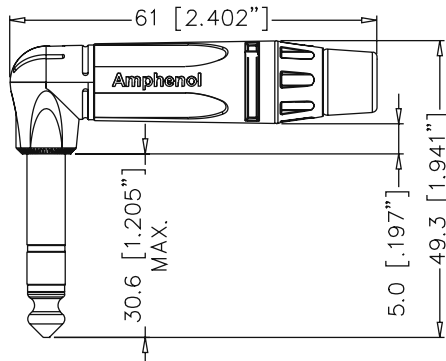
PRODUCT	DRAWING Dimensions in mm (inches)	DESCRIPTION	VARIATIONS	PART NO.
		1/4" (6.35mmø) Mono Phone plug, Right angle, Diecast Shell, Satin finish, Flexible grommet.	Standard	ACPM-TN
			Gold Contacts	ACPM-TN-AU
			Bulk Pack	ACPM-TN BULK
		1/4" (6.35mmø) Mono Phone plug, Right angle, Diecast Shell, Black finish, Flexible grommet.	Standard	ACPM-TB
			Gold Contacts	ACPM-TB-AU
			Bulk Pack	ACPM-TB BULK
		1/4" (6.35mmø) Stereo Phone plug, Right angle, Diecast Shell, Satin finish, Flexible grommet.	Standard	ACPS-TN
			Gold Contacts	ACPS-TN-AU
			Bulk Pack	ACPS-TN BULK
		1/4" (6.35mmø) Stereo Phone plug, Right angle, Diecast Shell, Black finish, Flexible grommet.	Standard	ACPS-TB
			Gold Contacts	ACPS-TB-AU
			Bulk Pack	ACPS-TB BULK

Plugs & Jacks

Musician Series II Plugs



Features:

- Mono or Stereo (TRS).
- Stylish shell design.
- Robust diecast shell in Satin nickel or Black finish.
- Nickel or Gold contact plating.
- Flexible grommet cable protection.
- Improved solderability.
- Precision machined contacts.
- Standard or Bulk packaging.
- Cable OD Entry to 6.5mm (0.256")

Options: Black Shell, Gold contacts.
Coloured grommets (ordered separately)

Specifications: Page 116

Clamp Info:







Cable O.D 3mm to 6.5mm
(0.118" to 0.256")

PRODUCT - FIGURE	DRAWING	DESCRIPTION	VARIATIONS	PART NUMBER
		1/4" (6.35mmø) Mono Phone plug, Diecast Shell, Satin finish, Flexible grommet.	Standard Gold Plated Contacts Bulk Pack	ACPM-GN ACPM-GN-AU ACPM-GN BULK
		1/4" (6.35mmø) Mono Phone plug, Diecast Shell, Black finish, Flexible grommet.	Standard Gold Plated Contacts Bulk Pack	ACPM-GB ACPM-GB-AU ACPM-GB BULK
		1/4" (6.35mmø) Stereo Phone plug, Diecast Shell, Satin finish, Flexible grommet.	Standard Gold Plated Contacts Bulk Pack	ACPS-GN ACPS-GN-AU ACPS-GN BULK
		1/4" (6.35mmø) Stereo Phone plug, Diecast Shell, Black finish, Flexible grommet.	Standard Gold Plated Contacts Bulk Pack	ACPS-GB ACPS-GB-AU ACPS-GB BULK

Plugs & Jacks

Musician Series II Plugs

PRODUCT - FIGURE	DRAWING	DESCRIPTION	TYPE	PART NUMBER
		1/4" (6.35mmø) Mono Phone plug, Right angle, Diecast Shell, Satin finish, Flexible grommet.	Standard	ACPM-RN
			Gold contacts	ACPM-RN-AU
			Bulk Pack	ACPM-RN BULK
		1/4" (6.35mmø) Mono Phone plug, Right angle, Diecast Shell, Black finish, Flexible grommet.	Standard	ACPM-RB
			Gold contacts	ACPM-RB-AU
			Bulk Pack	ACPM-RB BULK
		1/4" (6.35mmø) Stereo Phone plug, Right angle, Diecast Shell, Satin finish, Flexible grommet.	Standard	ACPS-RN
			Gold contacts	ACPS-RN-AU
			Bulk Pack	ACPS-RN BULK
		1/4" (6.35mmø) Stereo Phone plug, Right angle, Diecast Shell, Black finish, Flexible grommet.	Standard	ACPS-RB
			Gold contacts	ACPS-RB-AU
			Bulk Pack	ACPS-RB BULK

PART NUMBER BREAKDOWN

M / M SERIES II (MUSICIAN RANGE)

E. G . **ACPM-GB-AU BULK**
ACP (Series Prefix), **M**ale, **G**(Shell Type), **B**lack,
- **AU** (Gold Plated Contacts), **Bulk** Packaged.

SERIES PREFIX	ACP = Series Prefix
CONTACT TYPE	M = 2 pole (Mono)
	S = 3 pole Tip/Ring/Sleeve (Stereo)
SHELL TYPE	G = M Series Straight
	K = M Series II Straight
	R = M Series Right Angle
	T = M Series II Right Angle
SHELL FINISH	N = Satin Nickel
	B = Matt Black
CONTACT PLATING	Blank = Nickel Plating
	AU = Gold Plated
PACKAGING	Blank = Individual Bags
	BULK = Bulk Packed

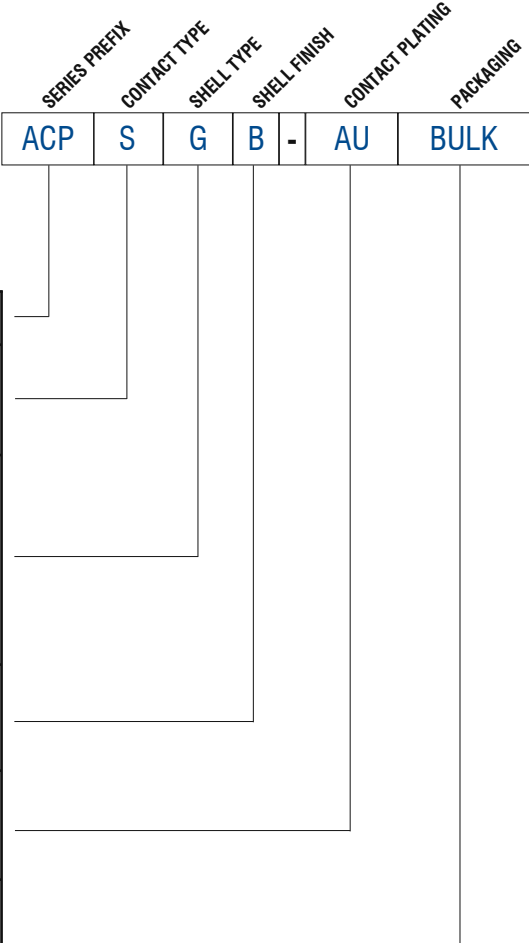

Plugs & Jacks

1/4" / 3.5mm Phone Jack Connectors



1/4" / 3.5MM PHONE JACK CONNECTORS

Amphenol phone connectors are available in 1/4" (6.35mm) and 3.5mm jack sockets or dual jack socket versions featuring combinations of both sizes. The standard heavy duty contacts provide excellent signal performance and the rugged designs excel in professional audio applications. Our wide range of options ensures we have the connector to suit your specific requirements. Custom jacks can also be developed to suit unique applications on request.

Applications

- Audio Cables and Snakes
- Amplifiers
- Speakers
- Mixing desks
- Rack mount equipment
- Patch panel

Features / Options – OEM RANGE Phone Jack

- Mono or Stereo (TRS)
- Stackable (Piggy back) mounting
- Vertical or horizontal PCB mount
- Mono and Stereo switched contacts
- Solder contacts
- Combo Contacts
- Metal nut
- Plastic Nut
- 1/4" (6.35mm)
- 3.5mm
- Dual 1/4" (6.35mm) and 3.5mm
- EMI Shielding plates
- Metal Mounting threads
- Plastic Mounting threads
- Chassis Ground connections
- Half, Full or No threads
- Grounded or Isolated Jacks

1/4" Phone Jack Grounding/ Shielding Options

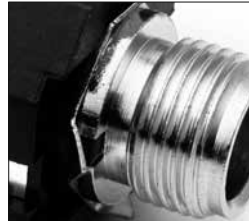

1/4" Gripper - Grounding points

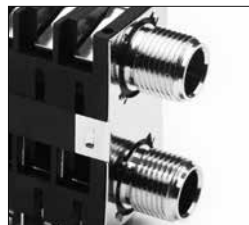

1/4" Shielding Plate

Ordering Codes

We have listed the more common ordering codes in each section. Please contact us if you need any further assistance.

Simple steps to guide you in using this catalogue

- 1) Identify the product group listed in Contents on page 1 and go directly to that page number.
- 2) Each product group cover page then details information and options available.
- 3) Refer to the product detail pages and identify the product you require pictorially.
- 4) Read the product description column for the products standard features.
- 5) Use variations column to determine your choice.
- 6) Identify part number.
- 7) In the event the particular option you require is not listed please refer to the part number breakdown page at the end of each section.
- 8) Please contact us directly if you have any further problems.

Plugs & Jacks

1/4" / 3.5mm Phone Jack Connectors

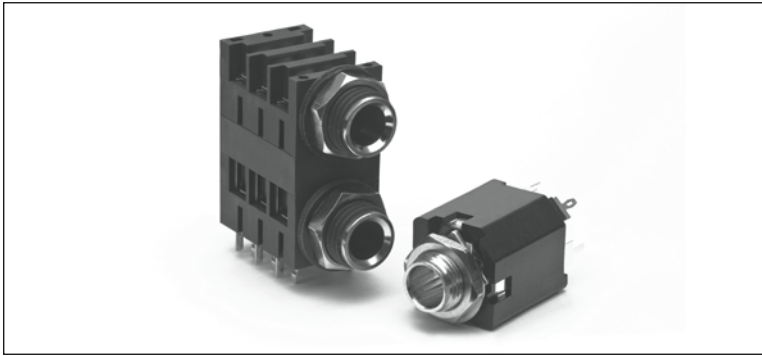

Features:

- 3.5mm and 6.35mm (1/4") options
- Mono or Stereo (TRS)
- Single or Dual mounting
- Vertical or Horizontal PCB mount
- Mono and Stereo with switching contacts
- Solder or Combo contacts
- Various mounting option

Schematic Chart: Page 114

Panel Cutouts: Page 113

PCB Footprints: Page 115

Specifications: Page 117

PRODUCT - FIGURE	DRAWING	DESCRIPTION	VARIATIONS	PART NUMBER
3.5MM PHONE JACKS				
		3.5mm Jack, Horizontal PCB, Plastic housing, Metal entry bore	Mono	ACJM-NH35
			Stereo	ACJS-NH35
		3.5mm Jack, Vertical PCB mount, Needle eye contacts, Plastic housing, Metal entry bore	Refer to Schematic Chart on page 114	ACJM-NV35-2 ACJM-NV35-2S ACJS-NV35-3 ACJS-NV35-3S ACJS-NV35-5
		3.5mm Jack, Vertical PCB mount, Needle eye contacts, Plastic housing, Metal thread and entry bore	Refer to Schematic Chart on page 114	ACJM-MV35-2 ACJM-MV35-2S ACJS-MV35-3 ACJS-MV35-3S ACJS-MV35-5
		3.5mm / 1/4" (6.35mmØ) Dual Phone Jack, (Piggyback), Horizontal PCB, Plastic housing, Metal nut and entry bore	Mono	ACJM-MHD985
			Stereo	ACJS-MHD985
		3.5mm / 1/4" (6.35mmØ) Dual Phone Jack, Vertical PCB mount, Needle eye contacts, Plastic housing, Metal nut and entry bore	Refer to Schematic Chart on page 114	ACJM-MVD985-2 ACJM-MVD985-2S ACJS-MVD985-3 ACJS-MVD985-3S ACJS-MVD985-5
1/4" PHONE JACKS HORIZONTAL				
		1/4" (6.35mmØ) Phone Jack, Horizontal Snap-fit PCB, Plastic housing, Half thread, Metal entry bore. Supplied without mounting hardware.	Mono	ACJM-HHDR
			Stereo	ACJS-HHDR

Plugs & Jacks

1/4" / 3.5mm Phone Jack Connectors

PRODUCT - FIGURE	DRAWING	Dimensions in mm (inches)	DESCRIPTION	VARIATIONS	PART NUMBER
			1/4" (6.35mm \varnothing) Phone Jack, Horizontal Snap-fit PCB, Plastic housing, Metal nut and entry bore	Mono	ACJM-MHDR
				Stereo	ACJS-MHDR
			1/4" (6.35mm \varnothing) Phone Jack, Horizontal Snap-fit PCB, Plastic housing, Metal thread, nut, washer and entry bore	Mono	ACJM-MHDRM
				Stereo	ACJS-MHDRM
			1/4" (6.35mm \varnothing) Offset Jack, Horizontal PCB mount, Plastic housing and entry bore with Half thread. Supplied without mounting hardware.	Refer to Schematic Chart on page 114	ACJM-HHOP
					ACJS-HHOP
			1/4" (6.35mm \varnothing) Offset Jack, Horizontal PCB mount, Plastic housing and entry bore with Half thread. Supplied without mounting hardware.	Refer to Schematic Chart on page 114	ACJM-HHOP-1
					ACJS-HHOP-1
			1/4" (6.35mm \varnothing) Offset Jack, Horizontal PCB mount, Plastic housing, thread and entry bore	Mono - Plastic Nut	ACJM-PHOP
				Mono - Metal Nut	ACJM-MHOP
				Stereo - Plastic Nut	ACJS-PHOP
				Stereo - Metal Nut	ACJS-MHOP
			1/4" (6.35mm \varnothing) Offset Jack, Horizontal PCB mount, Plastic housing, thread and entry bore. Non-switching sleeve contact with separate grounding to panel.	Refer to Schematic Chart on Page 110	ACJM-PHOP-1
				PHOP - Denotes Plastic Nut	ACJM-MHOP-1
				MHOP - Denotes Metal Nut	ACJS-PHOP-1
					ACJS-MHOP-1
			1/4" (6.35mm \varnothing) Offset Jack, Horizontal PCB mount, Plastic housing, Metal thread and entry bore with Chassis ground con- nection	Mono - Metal Nut	ACJM-MHOM
				Stereo - Metal Nut	ACJS-MHOM
			1/4" (6.35mm \varnothing) Jack, Horizontal PCB mount, Plastic housing with metal insert	Mono - Plastic Nut	ACJM - PH
				Mono - Metal Nut	ACJM - MH

Plugs & Jacks

1/4" / 3.5mm Phone Jack Connectors

PRODUCT - FIGURE	DRAWING	Dimensions in mm (inches)	DESCRIPTION	VARIATIONS	PART NUMBER
		8.0 [.315"] 24.8 [.976"] 15.3 [.602"] 20.0 [.787"] 4.00 [.157"] TYP	1/4" (6.35mmø) Jack, Horizontal PCB mount, Plastic housing with metal insert	Stereo - Plastic Nut	ACJS - PH
				Stereo - Metal Nut	ACJS - MH
		8.0 [.315"] 24.8 [.976"] 15.3 [.602"] 20.0 [.787"] 4.00 [.157"] TYP	1/4" (6.35mmø) Jack, Horizontal Snap-fit PCB mount, Plastic housing with metal insert	Mono - Plastic Nut	ACJM-PHR
				Mono - Metal Nut	ACJM-MHR
				Stereo - Plastic Nut	ACJS-PHR
				Stereo - Metal Nut	ACJS-MHR
		8.0 [.315"] 24.8 [.976"] 15.3 [.602"] 20.0 [.787"] 8.50 [.335"] TYP	1/4" (6.35mmø) Jack, Combination Horizontal PCB and Solder lug, Plastic housing with metal insert	Mono - Plastic Nut	ACJM-PC
				Mono - Metal Nut	ACJM-MC
				Stereo - Plastic Nut	ACJS-PC
				Stereo - Metal Nut	ACJS-MC
		8.0 [.315"] 24.8 [.976"] 15.3 [.602"] 20.0 [.787"] 7.56 [.298"] TYP	1/4" (6.35mmø) Jack, Solder Lug, Plastic housing with metal insert	Mono - Plastic Nut	ACJM-PHS
				Mono - Metal Nut	ACJM-MHS
				Stereo - Plastic Nut	ACJS-PHS
				Stereo - Metal Nut	ACJS-MHS
		8.0 [.315"] 11.00 [.433"] 4.00 [.157"] 20.00 [.787"] 32.10 [1.264"] 8.5 [.335"] 15.50 [.610"] 4.0 [.157"] TYP ø15.70 [.618"]	1/4" (6.35mmø) Jack, Solder Lug, Plastic housing and Bezel with threaded Metal nut.	Mono	ACJM-IHS
				Stereo	ACJS-IHS
		8.0 [.315"] 33.5 [1.317"] 8.5 [.335"] 15.5 [.610"] 20.00 [.787"] 4.00 [.157"]	1/4" (6.35mmø) Jack, Horizontal PCB mount, Plastic housing and Bezel with threaded Metal nut.	Mono	ACJM-IH
				Stereo	ACJS-IH
1/4" PHONE JACKS HORIZONTAL DUAL			1/4" (6.35mmø) Dual Phone Jack (Compact Piggyback), Horizontal Snap-fit PCB, Plastic housing, Metal nut and entry bore	Mono	ACJM-MHDC
		9.1 [.358"] 33.5 [1.319"] 23.05 [.907"] 16.55 [.652"] 29.3 [1.152"] 4.50 [.177"] TYP 6.50 [.256"]		Stereo	ACJS-MHDC
Stereo	ACJS-MHDCM				

Plugs & Jacks

1/4" / 3.5mm Phone Jack Connectors

PRODUCT - FIGURE	DRAWING	DESCRIPTION	VARIATIONS	PART NUMBER
		1/4" (6.35mmØ) Dual Phone Jack (Piggyback) Horizontal Snap-fit PCB, Plastic housing, Metal nut and entry bore	Mono	ACJM-MHD
			Stereo	ACJS-MHD
		1/4" (6.35mmØ) Dual Phone Jack (Piggyback) Shielding plate, Horizontal Snap-fit PCB, Plastic housing, Metal nut and entry bore	Mono	ACJM-MHDE
			Stereo	ACJS-MHDE
		1/4" (6.35mmØ) Dual Phone Jack (Piggyback), Horizontal Snap-fit PCB, Plastic housing, Metal thread, nut, washer and entry bore	Mono	ACJM-MHDM
			Stereo	ACJS-MHDM
		1/4" (6.35mmØ) Dual Phone Jack (Piggyback), Shielding plate Horizontal Snap-fit PCB, Plastic housing, Metal thread, nut and entry bore	Mono	ACJM-MHDEM
			Stereo	ACJS-MHDEM
1/4" PHONE JACKS VERTICAL		1/4" (6.35mmØ) Jack, Vertical PCB mount, Plastic housing, nut and entry bore	Refer to Schematic Chart on page 114	ACJM-PVB-2
	ACJM-PVB-2S			
	ACJS-PVB-3			
	ACJS-PVB-3S			
	ACJS-PVB-5			
		1/4" (6.35mmØ) Jack, Vertical PCB mount, Needle eye contacts, Plastic thread, Metal nut and insert	Refer to Schematic Chart on page 114	ACJM-MIV-2
				ACJM-MIV-2S
				ACJS-MIV-3
				ACJS-MIV-3S
				ACJS-MIV-5
		1/4" (6.35mmØ) Jack, Vertical PCB mount, Needle eye contacts, Star washer, Metal nut and insert	Refer to Schematic Chart on page 114	ACJM-MN-2
				ACJS-MN-3
				ACJM-MN-2S
				ACJS-MN-3S
				ACJS-MN-5
		1/4" (6.35mmØ) Jack, Vertical PCB mount, Metal nut and insert	Refer to Schematic Chart on page 114	ACJM-MV-2
				ACJM-MV-2S
				ACJS-MV-3
				ACJS-MV-3S
				ACJS-MV-5

Plugs & Jacks

1/4" / 3.5mm Phone Jack Connectors

SCHEMATIC CHART

PART NO.	ACJM-MV35-2 ACJM-MN-2 ACJM-NV35-2 ACJM-PVB-2 ACJM-MV-2 ACJM-MVS-2 ACJM-MIV-2	ACJM-MV35-2S ACJM-MN-2S ACJM-NV35-2S ACJM-PVB-2S ACJM-MV-2S ACJM-MVS-2S ACJM-MIV-2S	ACJS-MV35-3 ACJS-MN-3 ACJS-NV35-3 ACJS-PVB-3 ACJS-MV-3 ACJS-MVS-3 ACJS-MIV-3	ACJS-MV35-3S ACJS-MN-3S ACJS-NV35-3S ACJS-PVB-3S ACJS-MV-3S ACJS-MVS-3S ACJS-MIV-3S	ACJS-MV35-5 ACJS-MN-5 ACJS-NV35-5 ACJS-PVB-5 ACJS-MV-5 ACJS-MVS-5 ACJS-MIV-5
GENERAL SCHEMATIC					

PART NO.	ACJM-MVD985-2	ACJM-MVD985-2S	ACJS-MVD985-3	ACJS-MVD985-3S	ACJS-MVD985-5
SCHEMATIC					

PART NO.	ACJM-HHOP-1 ACJM-PHOP-1 ACJM-MHOP-1	ACJS-HHOP-1 ACJS-PHOP-1 ACJS-MHOP-1	ACJM-HHOP ACJM-PHOP ACJM-MHOP	ACJS-HHOP ACJS-PHOP ACJS-MHOP
GENERAL SCHEMATIC				

PCB FOOTPRINT - CONNECTOR SIDE OF PCB

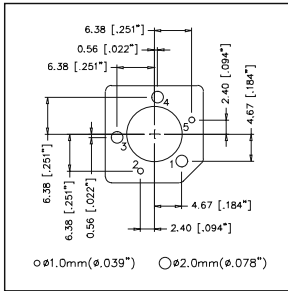

ACJM-MV
ACJS-MV
ACJM-MN-2
ACJS-MN-3
ACJM-MN-2S
ACJS-MN-3S
ACJM-MN-5
ACJS-MN-5
ACJM-NV35-XX
ACJS-NV35-XX
ACJM-MIV-2
ACJS-MIV-2
ACJM-MIV-3
ACJS-MIV-3
ACJM-MIV-5
ACJS-MIV-5

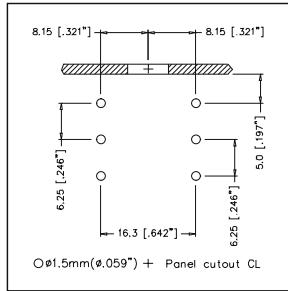

ACJM-PH
ACJM-MH
ACJS-PH
ACJS-MH
ACJM-PC
ACJM-MC
ACJS-PC
ACJS-MC

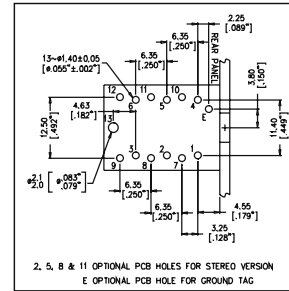

ACJM-MHD
ACJS-MHD
ACJM-MHDE
ACJS-MHDE
ACJM-MHDEM
ACJS-MHDEM
ACJM-MHDC
ACJS-MHDC
ACJM-MHDCM
ACJS-MHDCM
ACJM-MHDM
ACJS-MHDM

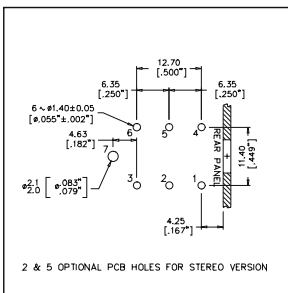

ACJM-MHDR
ACJS-MHDR
ACJM-PHR
ACJM-MHR
ACJS-PHR
ACJS-MHR
ACJM-HHDR
ACJS-HHDR
ACJM-MHDRM
ACJS-MHDRM

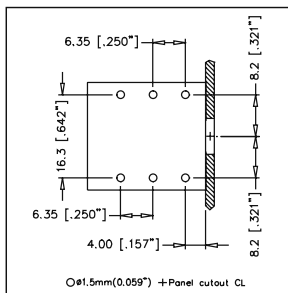

ACJS-IH
ACJM-IH

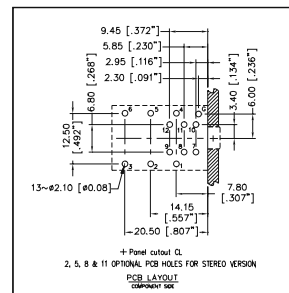

ACJS-MHD985
ACJM-MHD985

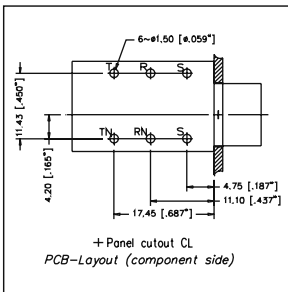

ACJS-MHOM
ACJM-MHOM

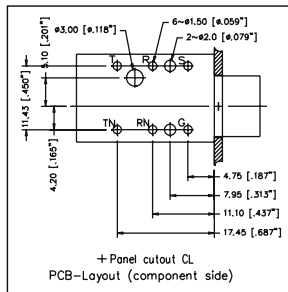

ACJS-MHOP-1
ACJS-PHOP-1
ACJS-HHOP-1
ACJM-MHOP-1
ACJM-PHOP-1
ACJM-HHOP-1

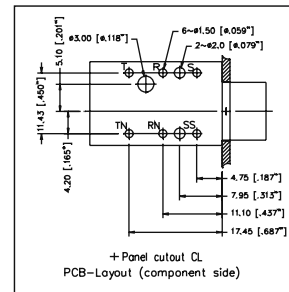

ACJS-MHOP
ACJS-PHOP
ACJM-MHOP
ACJM-PHOP
ACJM-HHOP
ACJS-HHOP

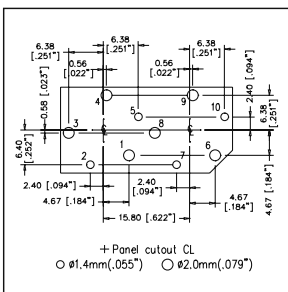

ACJS-MVD985
ACJM-MVD985

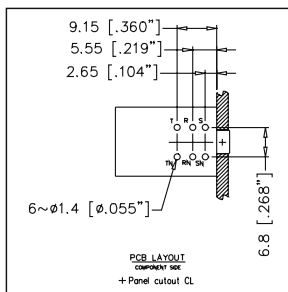

ACJS-NH35
ACJM-NH35

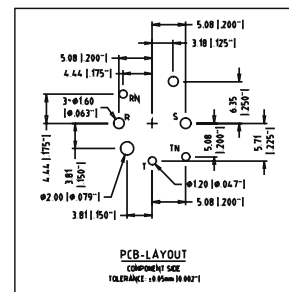

ACJM-PVB-2
ACJM-PVB-2S
ACJS-PVB-3
ACJS-PVB-3S
ACJM-PVB-5

Plugs & Jacks

1/4" / 3.5mm Phone Jack Connectors

1/4" PLUGS TECHNICAL DATA

		VALUE
GENERAL CHARACTERISTICS	Number of Contacts	2 Pole (Mono) 3 Pole Tip Ring Sleeve (Stereo)
	Termination	Solder
	Max. Wire Gauge - Stranded Wire	2 Pole (Mono): AWG 16 ~ 1.5mm ² 3 Pole (Stereo): AWG 18 ~ 1mm ²
	Flammability rating of insulating plastics	UL94V-0
	Solderability, complies with	IEC 68-2-20
	Environmental	Complies with EU RoHS 2 Directive 2011/65/EU
ELECTRICAL CHARACTERISTICS	Current Carrying Capacity	10A (Depends on Mating Connector and Cable)
	Typical Contact Resistance	Depends on Mating Connector
	Insulation resistance (initial) After Damp Heat Test	> 2GΩ ≥ 1GΩ
	Dielectric Withstand Voltage	2 Pole : 1.5 kV dc 3 Pole : 1 kV dc
CLIMATIC CHARACTERISTICS	Protection Class	IP40
	Operating Temperature	-25°C to +70°C (-13°F to 158°F)
MECHANICAL CHARACTERISTICS	Insertion and Withdrawal Force	≥ 10N - ≤ 30N
	Mating Cycles	Min. of 1000 cycles without any physical damage
	Cable O.D. - M Series - M Series II	3mm to 6.5mm (0.118" to 0.256") 6.5mm to 8mm (0.256" to 0.315")
MATERIALS	Connector Shell Material	Diecast Zinc Alloy EZDA No.3
	Connector Shell Finish	Satin Nickel or Black Polyester
	Insulators	UL94 V-0 PBT Resin or Modified PPE Resin and fibreglass laminate
	Cable Bushing	Santoprene
	Contact Plating	Brass / Ni over Cu (Copper)

Rev 4 - 05/2014

¹⁾ Approximate weight only, does not include packaging. Please contact us for exact weight for shipping purposes.

1/4" JACKS TECHNICAL DATA

		VALUE
GENERAL CHARACTERISTICS	Number of Contacts	2 Pole (Mono) 3 Pole Tip Ring Sleeve (Stereo)
	Termination	Solder, PCB or Combo
	Flammability rating of insulating plastics	UL94V-0 or UL94-HB
	Solderability, complies with	IEC 68-2-20
	Environmental	Complies with EU RoHS 2 Directive 2011/65/EU
ELECTRICAL CHARACTERISTICS	Current Carrying Capacity	10A (Depends on Mating Connector and Cable)
	Typical Contact Resistance	≤10mΩ
	Insulation resistance (initial) After Damp Heat Test	>2GΩ ≥10 ³ Meg Ω
	Rated Voltage Test Voltage AC RMS: Dielectric Strength	34V 500V
CLIMATIC CHARACTERISTICS	Protection Class	IP40
	Operating Temperature	-25°C to +70°C (-13°F to 158°F)
MECHANICAL CHARACTERISTICS	Insertion and Withdrawal Force	≥10N - ≤30N
	Mating Cycles	Min. of 10,000 cycles
	Weight - Straight - Right Angle	18g (0.039lb) 25g (0.055lb)
MATERIALS	Connector Housing	Nylon PA66 30% Glass Filled
	Metal Nut	Brass
	Plastic Nut	Nylon PA66 30% Glass Filled
	Washer	Fiber / Brass / Nylon PA66 30% Glass Filled
	Contact Plating	Tin - 4μm Min. over 2μm Min.Cu (Copper) Silver - 0.3μm Min. over 2μm Min.Cu (Copper) Nickel - 2μm Min. over 2μm Min.Cu (Copper) Gold Flash - 0.05μm Min. over 2μm Min.Cu (Copper)
	Contacts	Brass / Sn (Tin) over Cu (Copper)

Rev 7 - 04/2023

¹Approximate weight only, does not include packaging. Please contact us for exact weight for shipping purposes.

Plugs & Jacks

K Series Plugs (3.5mm)



K SERIES PLUGS (3.5MM)

Features:

- Mono or TRS (Stereo).
- AX Series inspired shell design.
- Suits Cable O.D from 2.5mm to 5mm (0.098" to 0.196")
- Robust diecast shell in Satin nickel or Black finish.
- Nickel or Gold contact plating.
- Flexible grommet cable protection.
- Improved solderability.
- Precision machined contacts.
- Standard or Bulk packaging.

Options: Black Shell, Gold contacts.

PRODUCT - FIGURE	DRAWING	Dimensions in mm (inches)	DESCRIPTION	VARIATIONS	PART NUMBER
		49 [1.911"] 35 [1.370"] ø10.3 [ø.406"]	3.5mm, Mono Phone plug, Diecast Shell, Satin finish, Flexible grommet.	Standard Gold Plated Contacts Bulk Pack	KM2P KM2P-AU KM2P BULK
		49 [1.911"] 35 [1.370"] ø10.3 [ø.406"]	3.5mm, Mono Phone plug, Diecast Shell, Black finish, Flexible grommet.	Standard Gold Plated Contacts Bulk Pack	KM2PB KM2PB-AU KM2PB BULK
		49 [1.911"] 35 [1.370"] ø10.3 [ø.406"]	3.5mm, Stereo Phone plug, Diecast Shell, Satin finish, Flexible grommet.	Standard Gold Plated Contacts Bulk Pack	KS3P KS3P-AU KS3P BULK
		49 [1.911"] 35 [1.370"] ø10.3 [ø.406"]	3.5mm, Stereo Phone plug, Diecast Shell, Black finish, Flexible grommet.	Standard Gold Plated Contacts Bulk Pack	KS3PB KS3PB-AU KS3PB BULK
		51 [2.008"] 37 [1.467"] 3.10 [.122"] ø10.3 [ø.406"]	3.5mm, Stereo Phone plug with extended shaft for mobile phones fitted with covers. Diecast Shell, Black Chrome finish, Flexible grommet	Standard Gold Plated Contacts	KS3PC KS3PC-AU

PART NUMBER BREAKDOWN

K-SERIES

E. G. **KS3P-AU BULK**
K (Series Prefix), **S3**(Stereo), Plug,
AU (Gold Plated Contacts), **Bulk** Packaged.

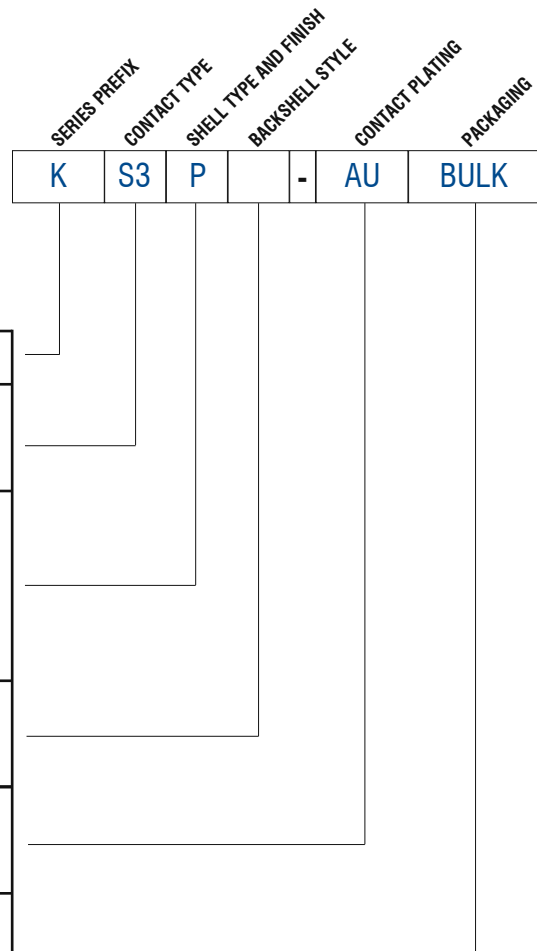

SERIES PREFIX	K	=	Series Prefix
CONTACT TYPE	M2	=	2 Pole (mono)
	S3	=	3 pole TRS (Stereo)
SHELL TYPE AND FINISH	P	=	Plug Satin Nickel
	PB	=	Plug Matt Black
	PC	=	Plug Black Chrome
BACKSHELL TYPE AND CABLE CLAMP	Blank	=	K Series to suit Cable O.D 2.5mm to 5mm (0.098" to 0.196")
CONTACT PLATING	Blank	=	Nickel Plated Contacts (Standard)
	AU	=	Gold Plated Contacts
PACKAGING	Blank	=	Individual Bags
	BULK	=	Bulk Packed

ISO VIEW OF KS3P

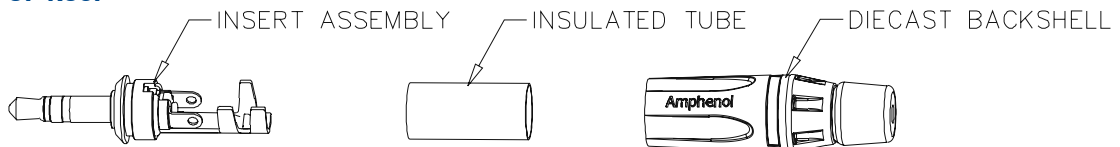

Plugs & Jacks

K Series Plugs (3.5mm)

3.5mm PLUG TECHNICAL DATA

		VALUE
GENERAL CHARACTERISTICS	Number of Contacts	2 Pole (Mono) 3 Pole Tip Ring Sleeve (Stereo)
	Termination	Solder
	Wire Gauge - Stranded Wire	2 Pole (Mono): AWG 16 - 1.5mm ² 3 Pole (Stereo): AWG 18 - 1mm ²
	Flammability rating of insulating plastics	UL94V-0
	Solderability, complies with	IEC 68-2-20
	Environmental	Complies with EU RoHS 2 Directive 2011/65/EU
ELECTRICAL CHARACTERISTICS	Current Carrying Capacity	>0.5mA (Depends on Mating Connector and Cable)
	Typical Contact Resistance	≤20mΩ (Depends on Mating Connector and Cable)
	Insulation resistance (initial) After Damp Heat Test	>200M Ω >100M Ω
	Test Voltage AC RMS: Dielectric Strength	250VAC
CLIMATIC CHARACTERISTICS	Protection Class	IP40
	Operating Temperature	-20°C to +65°C (-4°F to +149°F)
MECHANICAL CHARACTERISTICS	Insertion and Withdrawal Force	<20N / >3N (depends on mating connector)
	Cable O.D.	3mm to 5mm (0.118" to 0.196")
	Mechanical Operations	1000 mating cycles
	Weight	8g (0.017lb)
MATERIALS	Connector Shell Material (Plugs)	Diecast Zinc Alloy EZDA No.3
	Connector Shell Finish	Satin Nickel or Black Polyester
	Insulators	PA66
	Cable Bushing	Santoprene
	Contacts	Brass
	Plating	Nickel or Gold Flash

¹ Approximate weight only, does not include packaging. Please contact us for exact weight for shipping purposes.



PLUGS AND SOCKETS

Amphenol's plugs and sockets range continually expands to meet the needs of our customers. The success of the M-Series phone plugs led to the RCA series being developed. The Miniature XLR range was a natural progression from our standard XLR series as demand for smaller interconnects increased. The latest addition to the range is a professional grade 3.5mm phone plug designed for applications that require a robust interconnect.

Applications

- Audio Cables and Snakes
- Amplifiers
- Speakers
- Mixing desks
- Rack mount equipment
- Patch panel

Features / Options – RCA Plugs and Jacks

- Red, Black, White, Yellow, Blue or Green shell colours
- Stylish shell design
- Flexible grommet cable protection
- Gold Plated Contacts

Features / Options – Miniature XLR

- 3,4,5, or 6 contacts
- Solder cup
- Printed Circuit Board
- Vertical or Horizontal mounting
- Positive locking latch
- Flexible cable clamp
- Metal cable clamp
- Locking rings
- Chassis front mount
- Chassis middle or rear mount (on request)
- Optional black finish (on request)

Features / Options – 3.5mm Plugs Phone Jack

- Mono / Stereo TRS
- Solder contacts
- Suits cable O.D 2.5mm to 5mm
- Stylised shell design
- Flexible cable grommet
- Metal cable clamp
- Nickel or Gold contact plating
- Satin Nickel or Black finish

Cable Clamp Options



RCA Cable Clamp - M-Series, Cable O.D 3mm to 6.5mm (0.118" to 0.256")

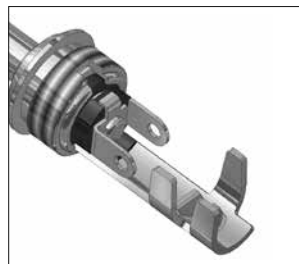

K-Series, Cable O.D 3mm to 5mm (0.118" to 0.196")

Ordering Codes

We have listed the more common ordering codes in each section. Please contact us if you need any further assistance.

Simple steps to guide you in using this catalogue

- 1) Identify the product group listed in Contents on page 1 and go directly to that page number.
- 2) Each product group cover page then details information and options available.
- 3) Refer to the product detail pages and identify the product you require pictorially.
- 4) Read the product description column for the products standard features.
- 5) Use variations column to determine your choice.
- 6) Identify part number.
- 7) In the event the particular option you require is not listed please refer to the part number breakdown page at the end of each section.
- 8) Please contact us directly if you have any further problems.

Plugs & Sockets

RCA Series









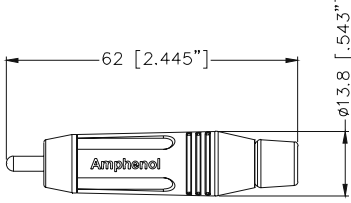

RCA SERIES

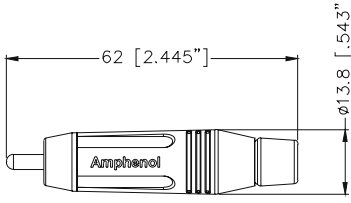
Features:

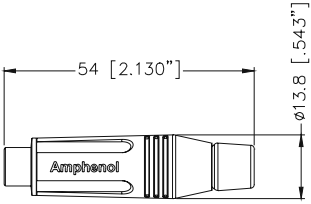
- Stylish design
- Flexible grommet cable protection
- Robust diecast shell
- Gold plated contacts
- Colour coded
- Good solderability
- Quick and easy assembly
- Panel mount utilises standard 'D' type housing

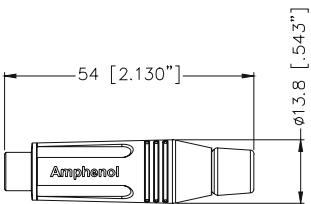
Part Number Breakdown: Page 123

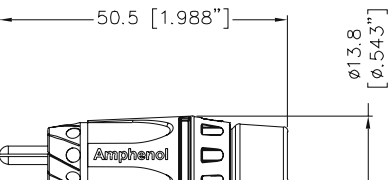
PRODUCT - FIGURE	DRAWING	Dimensions in mm (inches)	DESCRIPTION	VARIATIONS	PART NUMBER
		62 [2.445"] ø13.8 [.543"]	RCA Plug, Diecast Shell, Gold plated contacts, Coloured finish, Flexible coloured grommet	Red Black Yellow White Blue Green	ACPR-RED ACPR-BLK ACPR-YEL ACPR-WHT ACPR-BLU ACPR-GRN
		62 [2.445"] ø13.8 [.543"]	RCA Plug, Diecast Shell, Gold plated contacts, Satin finish, Flexible coloured grommet	Satin / Red Satin / Black Satin / Yellow Satin / White Satin / Blue Satin / Green	ACPR-SRD ACPR-SBK ACPR-SYL ACPR-SWH ACPR-SBL ACPR-SGR
		54 [2.130"] ø13.8 [.543"]	RCA Jack, Diecast Shell, Gold plated contacts, Coloured finish, Flexible coloured grommet	Red Black Yellow White Blue Green	ACJR-RED ACJR-BLK ACJR-YEL ACJR-WHT ACJR-BLU ACJR-GRN
		54 [2.130"] ø13.8 [.543"]	RCA Jack, Diecast Shell, Gold plated contacts, Satin finish, Flexible coloured grommet	Satin / Red Satin / Black Satin / Yellow Satin / White Satin / Blue Satin / Green	ACJR-SRD ACJR-SBK ACJR-SYL ACJR-SWH ACJR-SBL ACJR-SGR
		50.5 [1.988"] ø13.8 [ø .543"]	RCA Plug, Shortened Diecast Shell, Gold plated contacts, Black Chrome finish, Flexible coloured grommet	Red Black Yellow White Blue Green	ACPL-CRD ACPL-CBK ACPL-CYL ACPL-CWH ACPL-CBL ACPL-CGR

NOTE: RCA Series comply with EU RoHS 2 Directive 2011/65/EU

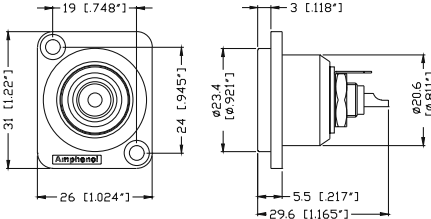
PRODUCT - FIGURE	DRAWING	Dimensions in mm (inches)	DESCRIPTION	VARIATIONS	PART NUMBER
			RCA Jack, Diecast Shell, Gold plated contacts, Nickel finish shell, coloured insulator.	Red Black Yellow White Blue Green	ACJD-RED ACJD-BLK ACJD-YEL ACJD-WHT ACJD-BLU ACJD-GRN

NOTE: RCA Series comply with EU RoHS 2 Directive 2011/65/EU

PART NUMBER BREAKDOWN

M SERIES RCA

E. G. **ACPR-RED BULK**
AC (Series Prefix), **P** (Plug, **R** (Shell type), **RED** (Shell and Grommet Colour),
Bulk Packaged.

SERIES PREFIX	CONTACT TYPE	SHELL TYPE	SHELL FINISH	PACKAGING	
AC	P	R	-	RED	BULK

SERIES PREFIX	AC	=	Series Prefix
CONTACT TYPE	J	=	RCA Female Jack
	P	=	RCA Male Plug
SHELL TYPE	R	=	Regular Shell Length
	L	=	Short Shell Length
	D	=	Chassis Jack 'D' Shell
SHELL AND GROMMET COLOUR	RED	=	Red, Red Grommet
	BLK	=	Black, Black Grommet
	YEL	=	Yellow, Yellow Grommet
	WHT	=	White, White Grommet
	BLU	=	Blue, Blue Grommet
	GRN	=	Green, Green Grommet
	SRD	=	Satin Nickel, Red Grommet
	CRD	=	Black Chrome, Red Grommet
	SBK	=	Satin Nickel, Black Grommet
	CBK	=	Black Chrome, Black Grommet
	SYL	=	Satin Nickel, Yellow Grommet
	CYL	=	Black Chrome, Yellow Grommet
	SWH	=	Satin Nickel, White Grommet
	CWH	=	Black Chrome, White Grommet
	SBL	=	Satin Nickel, Blue Grommet
	CBL	=	Black Chrome, Blue Grommet
	SGR	=	Satin Nickel, Green Grommet
	CGR	=	Black Chrome, Green Grommet
	NOTE: Denotes colour of insulator only on shell type D, Chassis Jack 'D' Shell. Shell finish is Nickel.		
PACKAGING	Blank	=	Individual Bags
	BULK	=	Bulk Packed

RCA TECHNICAL DATA

		VALUE
GENERAL CHARACTERISTICS	Number of Contacts	2
	Termination	Solder
	Max. Wire Gauge - Stranded Wire	AWG 14 - 2.5mm ²
	Flammability rating of insulating plastics	UL94V-0
	Solderability, complies with	IEC 68-2-20
Environmental	Complies with EU RoHS 2 Directive 2011/65/EU	
ELECTRICAL CHARACTERISTICS	Current Carrying Capacity	10A (Depends on Mating Connector)
	Typical Contact Resistance	≤10mΩ (Depends on Mating Connector)
	Insulation resistance (initial) After Damp Heat Test	>2GΩ ≥ 10 ³ Meg Ω
	Dielectric Strength	1500 V dc
CLIMATIC CHARACTERISTICS	Protection Class	IP40
	Operating Temperature	-25°C to +75°C (-13°F to +167°F)
MECHANICAL CHARACTERISTICS	Insertion and Withdrawal Force	≥ 10N - ≤ 30N (depends on mating connector)
	Cable O.D.	3mm to 7mm (0.118" to 0.275")
	Mechanical Operations	500 mating cycles
	Weight - Cable Mount - Panel Mount	18g (0.039lb) 30g (0.066lb)
MATERIALS	Connector Shell Material (Plugs)	Diecast Zinc Alloy EZDA No.3
	Connector Shell Finish	Satin Nickel or Coloured Polyester
	Insulators	PA66
	Cable Bushing	Thermoplastic Polyurethane
	Contacts	Brass Alloy
	Plating	Gold Flash

Rev 4 - 05/2014

¹⁾Approximate weight only, does not include packaging. Please contact us for exact weight for shipping purposes.



MULTIPIN CONNECTORS

Amphenol has an extensive range of circular and rectangular multi-pin connectors ideally suited to the entertainment industry. Featuring rugged housings and precision made contacts these connectors have proven themselves in the most demanding of applications. The extensive arrangement of different connector sizes and contact numbers ensure we can offer a solution to your multi-pin wiring applications.

Applications

- Audio Cables and Snakes
- Lighting control
- Concert Touring Systems
- Outside Broadcast Systems

Features / Options - MP-41 Series

- 13 to 85 pins with Crimp / Solder bucket contacts
- 150 pins with Crimp contacts only
- 4 to 48 channel
- Gold plated contacts
- Synthetic inserts
- Environmental resistant
- Positive Bayonet locking
- PG cable gland
- 2000 mating cycles
- Bayonet wear pins
- Extended coupling ring
- Metal Housings

Features / Options - MP-62 Series

- 39 or 61 Solder bucket contacts
- Gold plated contacts
- Neoprene inserts
- Environmental resistant
- Positive Bayonet locking
- PG cable gland or NPT thread
- Metal Housings

Ordering Codes

We have listed the more common ordering codes in each section. For further options please contact us.

Simple steps to guide you in using this catalogue

- 1) Identify the product group listed in Contents on page 1 and go directly to that page number.
- 2) Each product group cover page then details information and options available.
- 3) Refer to the product detail pages and identify the product you require pictorially.
- 4) Read the product description column for the products standard features.
- 5) Use pins column to determine number of contacts.
- 6) Identify part number.
- 7) In the event the particular option you require is not listed please refer to the part number breakdown page at the end of each section.
- 8) Please contact us directly if you have any further problems.

Multipin Connectors

MP-41 Series



MP-41 SERIES

Amphenol's MP-41 series of multipin connectors utilise the same design principals of the rugged Mil-C-5015 military connectors. They can withstand high shock and vibration environments and are ideal for tough on-road applications. Featuring a quick mating bayonet coupling with an audible full mating feature ensures a positive connection every time. Available from 13 to 150 pins with contacts supplied with each connector as standard.

Features:



- 13 to 85 pins with Crimp/Solder bucket contacts
- 150 pins with Crimp contacts only
- 4 to 48 channels
- Gold plated contacts
- Synthetic insert
- Protective dust caps
- Industry standard compatible
- 2000 mating cycles
- Black finish
- Positive bayonet locking
- PG cable glands
- IP67 rated
- Metal housings

Options: NPT threaded backshells.

Crimp Tooling: Page 129

Specifications: Page 130 **Part Number Breakdown:** Page 129

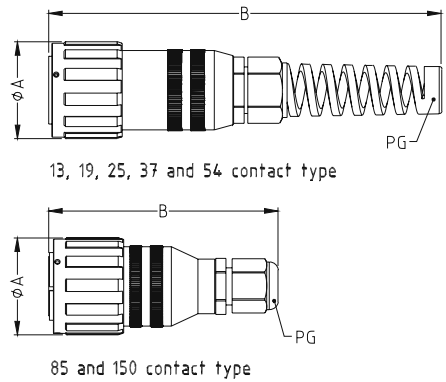

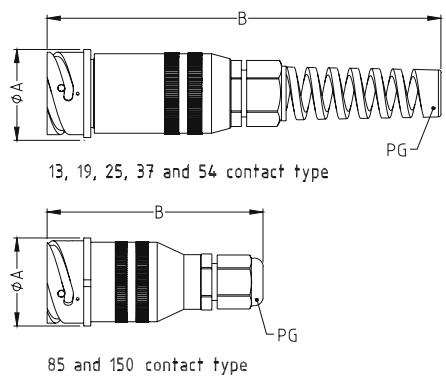
Wiring Information: Page 141

PRODUCT - FIGURE	Dimensions in mm (inches) DRAWING	Dimensions in mm (inches)			PINS	PART NUMBER	PART NUMBER With Dustcap
		A	B	PG			
 <p>Straight cable plug with socket contacts, Black finish, supplied complete with contacts.</p> <p>13, 19, 25, 37 and 54 contact type</p> <p>85 and 150 contact type</p>		40.5 (1.60)	160 (6.30)	11	13	MP-4106-13S	MP-4106-13S-C
		44 (1.73)	171 (6.73)	13.5	19	MP-4106-19S	MP-4106-19S-C
		46.6 (1.83)	193 (7.60)	16	25	MP-4106-25S	MP-4106-25S-C
		54.3 (2.14)	210 (8.26)	21	37	MP-4106-37S	MP-4106-37S-C
		60.1 (2.36)	210 (8.26)	21	54	MP-4106-54S	MP-4106-54S-C
		73.3 (2.88)	137 (5.40)	29	85	MP-4106-85S	MP-4106-85S-C
		73.3 (2.88)	145 (5.70)	36	150	MP-4106-150S	MP-4106-150S-C
		 <p>Cable connecting receptacle with pin contacts, black finish, supplied complete with contacts.</p> <p>13, 19, 25, 37 and 54 contact type</p> <p>85 and 150 contact type</p>		37.8 (1.49)	160 (6.30)	11	13
41.1 (1.62)	171 (6.73)			13.5	19	MP-4101-19P	MP-4101-19P-C
41.5 (1.63)	193 (7.60)			16	25	MP-4101-25P	MP-4101-25P-C
51 (2.00)	210 (8.26)			21	37	MP-4101-37P	MP-4101-37P-C
57.1 (2.25)	210 (8.26)			21	54	MP-4101-54P	MP-4101-54P-C
70 (2.75)	137 (5.40)			29	85	MP-4101-85P	MP-4101-85P-C
70 (2.75)	145 (5.70)			36	150	MP-4101-150P	MP-4101-150P-C

Note: NPT threaded backshells available on request. Please contact us.

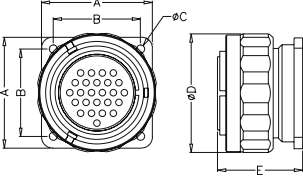

Multipin Connectors

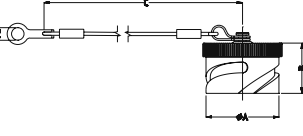
MP-41 Series

PRODUCT - FIGURE	Dimensions in mm (inches) DRAWING	Dimensions in mm (inches)						PINS	PART NUMBER	PART NUMBER With Dustcap
		A	B	C	D	E	F			
 	Panel plug with socket contacts, black finish, supplied complete with contacts.	38 (1.49)	29.4 (1.15)	3.2 (0.13)	40.5 (1.60)	38.8 (1.53)	N/A	13	MP-4164-13S	MP-4164-13S-C
		41 (1.61)	31.8 (1.25)	3.2 (0.13)	44 (1.73)	38.8 (1.53)	N/A	19	MP-4164-19S	MP-4164-19S-C
		44.5 (1.75)	34.9 (1.37)	3.73 (0.14)	48.51 (1.91)	40.6 (1.60)	N/A	25	MP-4164-25S	MP-4164-25S-C
		50.8 (1.99)	39.7 (1.56)	3.73 (0.14)	54.3 (2.14)	42 (1.65)	N/A	37	MP-4164-37S	MP-4164-37S-C
		57 (2.24)	44.5 (1.75)	4.39 (0.17)	60.8 (2.40)	45 (1.77)	N/A	54	MP-4164-54S	MP-4164-54S-C
		69.8 (2.74)	55.5 (2.18)	4.39 (0.17)	73.3 (2.88)	45 (1.77)	N/A	85	MP-4164-85S	MP-4164-85S-C
		69.8 (2.74)	55.5 (2.18)	4.39 (0.17)	73.3 (2.88)	45 (1.77)	N/A	150	MP-4164-150S	MP-4164-150S-C
		38 (1.49)	29.4 (1.15)	3.23 (0.13)	34.2 (1.34)	34.5 (1.35)	29 (1.14)	13	MP-4102-13P	MP-4102-13P-C
		41 (1.61)	31.8 (1.25)	3.23 (0.13)	37.4 (1.47)	34.5 (1.35)	32.2 (1.26)	19	MP-4102-19P	MP-4102-19P-C
		44.5 (1.75)	34.9 (1.37)	3.73 (0.14)	40.9 (1.61)	35.7 (1.40)	35.3 (1.38)	25	MP-4102-25P	MP-4102-25P-C
50.8 (1.99)	39.7 (1.56)	3.73 (0.14)	46.7 (1.83)	36.5 (1.44)	41.4 (1.62)	37	MP-4102-37P	MP-4102-37P-C		
57 (2.24)	44.5 (1.75)	4.30 (0.17)	53.4 (2.10)	38.5 (1.52)	47.8 (1.88)	54	MP-4102-54P	MP-4102-54P-C		
69.8 (2.74)	55.5 (2.18)	4.30 (0.17)	65.5 (2.57)	38.5 (1.52)	59 (2.32)	85	MP-4102-85P	MP-4102-85P-C		
69.8 (2.74)	55.5 (2.18)	4.30 (0.17)	65.5 (2.57)	38.5 (1.52)	59 (2.32)	150	MP-4102-150P	MP-4102-150P-C		
 	Plug protective dustcap to suit MP-4164 type.	34.16 (1.35)	31.5 (1.24)	110 (4.33)	4.7 (0.18)	-	-	13	MP-25042-13S	-
		37.36 (1.47)	31.5 (1.24)	110 (4.33)	4.7 (0.18)	-	-	19	MP-25042-19S	-
		40.87 (1.61)	31.5 (1.24)	110 (4.33)	4.7 (0.18)	-	-	25	MP-25042-25S	-
		46.68 (1.84)	31.5 (1.24)	110 (4.33)	4.7 (0.18)	-	-	37	MP-25042-37S	-
		53.36 (2.10)	31.5 (1.24)	110 (4.33)	5.5 (0.22)	-	-	54	MP-25042-54S	-
		65.48 (2.58)	31.5 (1.24)	110 (4.33)	5.5 (0.22)	-	-	85	MP-25042-85S	-
		65.48 (2.58)	31.5 (1.24)	110 (4.33)	5.5 (0.22)	-	-	150	MP-25042-150S	-
		38.8 (1.53)	20.7 (0.81)	255 (8.07)	-	-	-	13	MP-25042-13L	-
41.6 (1.64)	20.7 (0.81)	255 (8.07)	-	-	-	19	MP-25042-19L	-		
45.3 (1.78)	20.7 (0.81)	255 (8.07)	-	-	-	25	MP-25042-25L	-		
52.15 (2.05)	20.7 (0.81)	255 (8.07)	-	-	-	37	MP-25042-37L	-		
58.6 (2.30)	20.7 (0.81)	255 (8.07)	-	-	-	54	MP-25042-54L	-		
70.7 (2.78)	20.7 (0.81)	255 (8.07)	-	-	-	85	MP-25042-85L	-		
70.7 (2.78)	20.7 (0.81)	255 (8.07)	-	-	-	150	MP-25042-150L	-		

Multipin Connectors

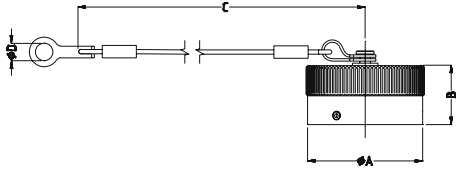
MP-41 Series

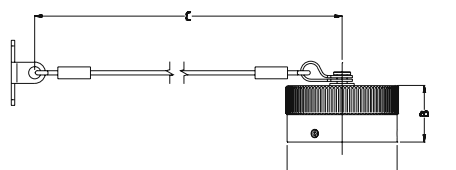
PRODUCT - FIGURE	Dimensions in mm (inches) DRAWING	Dimensions in mm (inches)						PINS	PART NUMBER
		A	B	C	D	E	F		
	<p>Plug protective dustcap to suit MP-4102 types.</p> 	34.16 (1.35)	31.5 (1.24)	110 (4.33)	4.7 (0.18)	-	-	13	MP-25043-13S
		37.36 (1.47)	31.5 (1.24)	110 (4.33)	4.7 (0.18)	-	-	19	MP-25043-19S
		40.87 (1.61)	31.5 (1.24)	110 (4.33)	4.7 (0.18)	-	-	25	MP-25043-25S
		46.68 (1.84)	31.5 (1.24)	110 (4.33)	4.7 (0.18)	-	-	37	MP-25043-37S
		53.36 (2.10)	31.5 (1.24)	110 (4.33)	5.5 (0.22)	-	-	54	MP-25043-54S
		65.48 (2.58)	31.5 (1.24)	110 (4.33)	5.5 (0.22)	-	-	85	MP-25043-85S
		65.48 (2.58)	31.5 (1.24)	110 (4.33)	5.5 (0.22)	-	-	150	MP-25043-150S
			<p>Receptacle protective dustcap to suit MP-4101 types.</p> 	38.8 (1.53)	20.7 (0.81)	255 (8.07)	-	-	-
41.6 (1.64)	20.7 (0.81)			255 (8.07)	-	-	-	19	MP-25043-19L
45.3 (1.78)	20.7 (0.81)			255 (8.07)	-	-	-	25	MP-25043-25L
52.15 (2.05)	20.7 (0.81)			255 (8.07)	-	-	-	37	MP-25043-37L
58.6 (2.30)	20.7 (0.81)			255 (8.07)	-	-	-	54	MP-25043-54L
70.7 (2.78)	20.7 (0.81)			255 (8.07)	-	-	-	85	MP-25043-85L
70.7 (2.78)	20.7 (0.81)			255 (8.07)	-	-	-	150	MP-25043-150L

Multipin Connectors

MP-41 Series

PRODUCT - FIGURE	DRAWING	DESCRIPTION	NO. OF PINS	PART NUMBER
	N/A	Crimp Tool	All	M22520/1-01
	N/A	Positioner / Turret	All	TH29-1
	N/A	Insertion tool	13-85	MP-INS-16
			150	MP-INS-18
	N/A	Extraction tool	All	MP-EXT-16/18
	N/A	Contact Pilot Pin	13-85	MP-GUIDE-16
			150	MP-GUIDE-18
	N/A	Solder/Crimp Pin Contact	13-85 (Size 16)	MP-108400
		Crimp Pin Contact (Soldering of this contact is not recommended)	150 (Size 18)	MP-108300
	N/A	Solder/Crimp Socket Contact	13-85 (Size 16)	MP-108600
		Crimp Socket Contact (Soldering of this contact is not recommended)	150 (Size 18)	MP-108500

NOTE: Complete instructions for providing reliable crimped wire to contact terminations and inserting proprietary contacts in MP-41 Series connectors are available in publication PI523 located on our website www.amphenolaudio.com.

PART NUMBER BREAKDOWN MP-41 SERIES

MULTIPIN CIRCULAR CONNECTORS

E. G. **MP-4106-85S**
Multipin, **4106** Cable Plug, **85** Contacts, **S** Female Socket Contacts,

SERIES PREFIX	MP	=	Series Prefix
HOUSING TYPE	4101	=	Inline cable connecting receptacle
	4102	=	Panel receptacle
	4106	=	Cable plug
	4164	=	Panel plug
	25042S	=	Dustcap for panel plug
	25042L	=	Dustcap for cable plug
	25043S	=	Dustcap for panel receptacle
	25043L	=	Dustcap for cable receptacle
NO. OF CONTACTS			13, 19, 25, 37, 54, 85, 150
GENDER <small>*Not required for dustcap part numbers</small>	P	=	Male pin contacts
	S	=	Female socket contacts
OPTIONS	C	=	Supplied with Dustcap

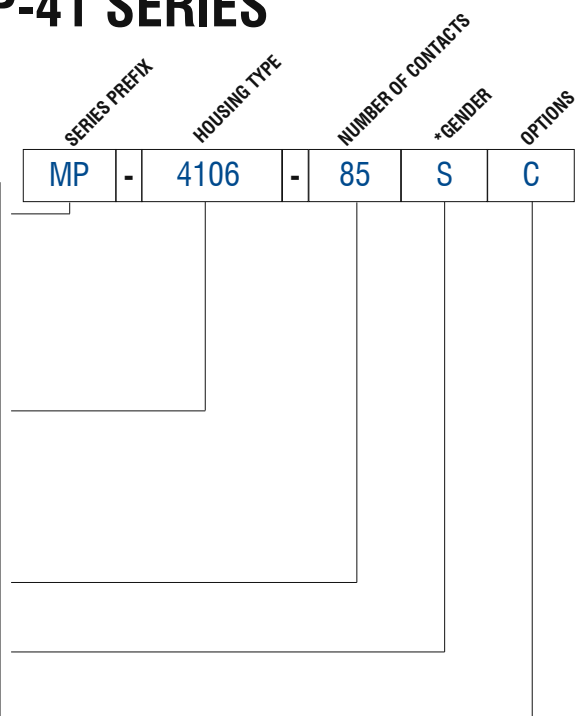

Multipin Connectors

MP-41 Series

STANDARD DATA MP-41 SERIES

		VALUE						
GENERAL CHARACTERISTICS	Number of contacts	13	19	25	37	54	85	150
	Number of channels	4	6	8	12	16	28	48
	Termination	Solder / Crimp "Combo"						Crimp
	Wire Gauge - Stranded Wire	16AWG - 20AWG						18AWG
	Environmental	Complies with EU RoHS 2 Directive 2011/65/EU						
ELECTRICAL CHARACTERISTICS	Operating Voltage at Sea level - DC	250V*						250V*
	Operating Voltage at Sea level - AC	200V*						200V*
	Test Voltage AC RMS	1000V						1000V
	Current Carrying Capacity	13A						7.5A
	Typical Contact Resistance	3.46mΩ						11.25mΩ
	Insulation Resistance	5000MΩ						
CLIMATIC CHARACTERISTICS	Protection Class	IP67 (when mated)						
	Operating Temperature	-55°C to +125°C (-67°F to +257°F)						
MECHANICAL CHARACTERISTICS	Cable Retention	PG Gland						
	Mechanical Operations	2000 mating cycles						
MATERIALS	Connector / Shell Finish	Aluminium Alloy / Black						
	Insert	Synthetic Insert to MIL-R-3065						
	Male pin contact / Plating	Brass / Gold plated						
	Female socket contact / Plating	Brass / Gold plated						
CLAMPING CHARACTERISTICS	PG Gland	11	13.5	16	21	29	36	
	Cable Clamping range	mm	4-10	5-12	9-14	13-18	14-25	19-32
	(inches)	(0.15"-0.39")	(0.19"-0.47")	(0.35"-0.55")	(0.51"-0.70")	(0.55"-0.98")	(0.74"-1.25")	

*Not suitable for domestic applications above 50V

Rev 2 - 03/2013













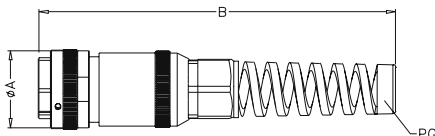

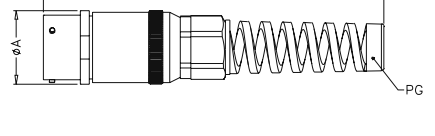

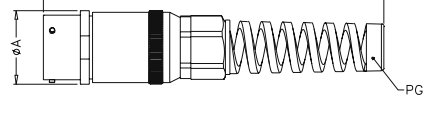
MP-62/65 SERIES

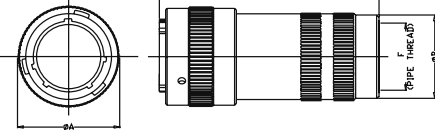
Amphenol's Multipin MP-62 series of circular connectors utilise the same design principles as the Mil-C-26482 military connectors. Featuring a three point quick mating bayonet coupling and five key polarisation ensuring a positive connection every time. Available in two contact pin layouts 39 and 61 with gold plated solder contacts fitted as standard.

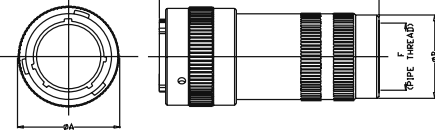
Features:

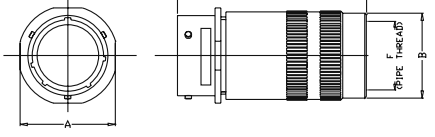
- 39 or 61 pins.
- Gold plated solder contacts.
- Neoprene insert.
- Protective dust caps
- Metal housings
- Environmental resistant.
- Black finish.
- Positive bayonet locking
- PG cable glands

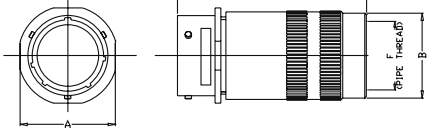
Specifications: Page 133 **Wiring Info: Page 141**

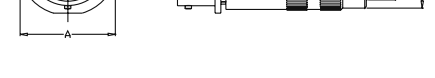
PRODUCT - FIGURE	Dimensions in mm (inches) DRAWING	Dimensions in mm (inches)			PINS	PART NUMBER	PART NUMBER With Dustcap
		A	B	PG			
	Straight cable plug with pin contacts, Black finish, Gold plated solder contacts. 	38.9	181.5	16	39	MP-6216-39P	MP-6216-39P-C
		(1.53)	(7.15)				
	Straight cable plug with pin contacts, Black finish, Gold plated solder contacts. 	45.5	193	21	61	MP-6216-61P	MP-6216-61P-C
		(1.80)	(7.60)				
	Cable connecting receptacle with socket contacts, Black finish, Gold plated solder contacts. 	36.7	181.5	16	39	MP-6211-39S	MP-6211-39S-C
		(1.45)	(7.15)				
	Cable connecting receptacle with socket contacts, Black finish, Gold plated solder contacts. 	43.0	193	21	61	MP-6211-61S	MP-6211-61S-C
		(1.70)	(7.60)				
	Straight cable plug with pin contacts, NPT 3/4" threaded backshell, Black finish, Gold plated solder contacts. 	38.9	90	NPT	39	MP-6516-39P	MP-6516-39P-C
		(1.53)	(3.54)	3/4"			
	Straight cable plug with pin contacts, NPT 3/4" threaded backshell, Black finish, Gold plated solder contacts. 	45.5	100	NPT	61	MP-6516-61P	MP-6516-61P-C
		(1.80)	(3.94)	3/4"			
	Cable connecting receptacle with socket contacts, NPT 3/4" threaded backshell, Black finish, Gold plated solder contacts. 	36.7	90	NPT	39	MP-6511-39S	MP-6511-39S-C
		(1.45)	(3.54)	3/4"			
	Cable connecting receptacle with socket contacts, NPT 3/4" threaded backshell, Black finish, Gold plated solder contacts. 	43.0	100	NPT	61	MP-6511-61S	MP-6511-61S-C
		(1.70)	(3.94)	3/4"			

Multipin Connectors

MP-62/65 Series

PRODUCT - FIGURE	DRAWING Dimensions in mm (inches)	Dimensions in mm (inches)						PINS	PART NUMBER	PART NUMBER With Dustcap
		A	B	C	D	E	F			
	<p>Panel plug with pin contacts, Black finish, Gold plated solder contacts.</p>	38.86	29.36	6-32	39.0	32	-	39	MP-6256-39P	MP-6256-39P-C
		(1.53)	(1.16)	UNC	(1.54)	(1.26)	-			
	<p>Panel receptacle plug with socket contacts, Black finish, Gold plated solder contacts.</p>	43.94	34.93	6-32	45.5	35	-	61	MP-6256-61P	MP-6256-61P-C
		(1.73)	(1.38)	UNC	(1.80)	(1.38)	-			
	<p>Panel receptacle plug with socket contacts, Black finish, Gold plated solder contacts.</p>	36.7	29.36	3.05	31.8	22.3	30.1	39	MP-6212-39S	MP-6212-39S-C
		(1.44)	(1.15)	(0.12)	(1.25)	(0.87)	(1.18)			
	<p>Panel receptacle plug with socket contacts, Black finish, Gold plated solder contacts.</p>	43.0	34.93	3.74	38.1	22.3	36.4	61	MP-6212-61S	MP-6212-61S-C
		(1.69)	(1.38)	(0.15)	(1.50)	(0.87)	(1.43)			

PRODUCT - FIGURE	DRAWING Dimensions in mm (inches)	DESCRIPTION	Dimensions in mm (inches)				PINS	PART NUMBER
			A	B	C	D		
	<p>Plug protective dustcap to suit MP-6256</p>		31.7	15.9	127	4.40	39	MP-742-39S
			(1.25)	(0.62)	(4.99)	(0.17)		
	<p>Plug protective dustcap to suit MP-6256</p>		38.05	16.70	127	4.40	61	MP-742-61S
			(1.50)	(0.66)	(4.99)	(0.17)		
	<p>Receptacle protective dustcap to suit MP-6216</p>		36.9	13.13	127	-	39	MP-742-39L
			(1.45)	(0.52)	(4.99)	-		
	<p>Receptacle protective dustcap to suit MP-6216</p>		43.14	14.15	127	-	61	MP-742-61L
			(1.70)	(0.56)	(4.99)	-		
	<p>Plug protective dustcap to suit MP-6212</p>		31.7	15.9	127	4.40	39	MP-738-39S
			(1.25)	(0.62)	(4.99)	(0.17)		
	<p>Plug protective dustcap to suit MP-6212</p>		38.05	16.70	127	4.40	61	MP-738-61S
			(1.50)	(0.66)	(4.99)	(0.17)		
	<p>Receptacle protective dustcap to suit MP-6211</p>		36.9	13.13	127	-	39	MP-738-39L
			(1.45)	(0.52)	(4.99)	-		
	<p>Receptacle protective dustcap to suit MP-6211</p>		43.14	14.15	127	-	61	MP-738-61L
			(1.70)	(0.56)	(4.99)	-		

STANDARD DATA MP-62 SERIES / MP - 65 SERIES

		VALUE	
GENERAL CHARACTERISTICS	Number of contacts	39	61
	Number of channels	12	20
	Termination	Solder	
	Wire Gauge - Stranded Wire	37 x 24AWG-20AWG 2 x 20AWG-16AWG	24AWG-20AWG
	Environmental	Complies with EU RoHS 2 Directive 2011/65/EU	
ELECTRICAL CHARACTERISTICS	Operating Voltage at Sea level - DC	600V*	
	Operating Voltage at Sea level - AC	600V*	
	Test Voltage AC RMS	1500V	
	Current Carrying Capacity	37 x 7.5A 2 x 13A	7.5A
	Insulation Resistance	5000MΩ	
CLIMATIC CHARACTERISTICS	Protection Class	IP67 (when mated)	
	Operating Temperature	-55°C to +125°C (-67°F to +257°F)	
MECHANICAL CHARACTERISTICS	Cable Retention	PG Gland / NPT Thread	
	Mechanical Operations	500 mating cycles (minimum)	
MATERIALS	Connector / Shell Finish	Aluminium Alloy / Black	
	Insert	Neoprene	
	Male pin contact machined - Plating	Brass / Gold plated	
	Female socket contact machined - Plating	Brass / Gold plated	
CLAMPING CHARACTERISTICS	PG Gland	16	21
	Cable Clamping range mm (inches)	9-14 (0.35"-0.55")	13-18 (0.51"-0.70")

Rev 3 - 03/2013

*Not suitable for domestic applications above 50V



AMPHENOL-TUCHEL C146 HEAVY | MATE CONNECTORS

Amphenol Tuchel C146 series rectangular connectors feature modular components ensuring a vast range of different features and benefits for the end user. The zinc diecast aluminum housings are finished in a durable powder coat and available in either top or side entry. Connector coupling is achieved via a positive locking lever ensuring a positive rapid connection. The C146 series is suitable for general-purpose audio and lighting applications and is completely intermateable with all competitor connectors.







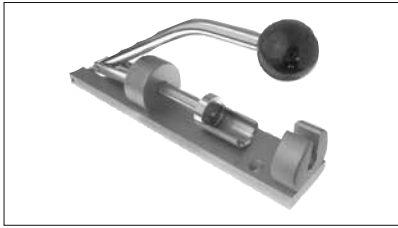





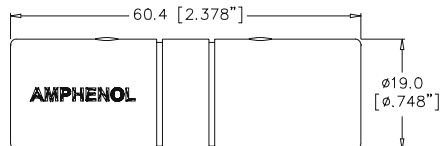

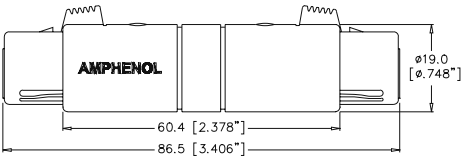

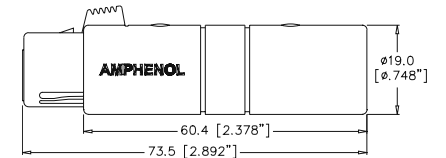
FIBRE OPTIC

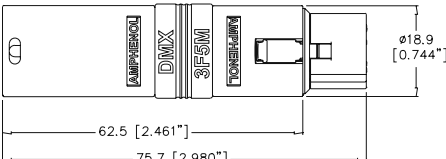
Amphenol has over 25 years experience in fibre optics dating back to their development of the first industry standard connector, the SMA. Today we can offer a complete range of products including Hybrid Fibre optic connectors for HDTV broadcast cameras SMPTE 304M compliant and ruggedised connectors and cable assemblies for indoor or outdoor applications.

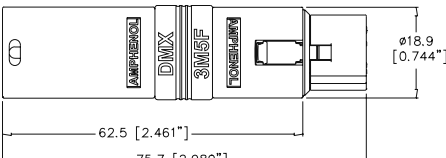

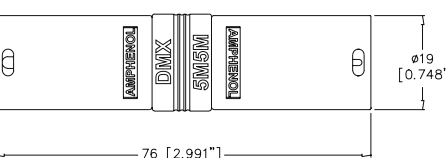

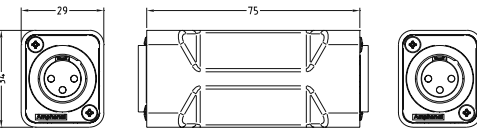
ACCESSORIES

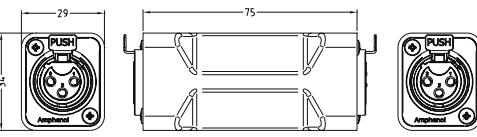
- Colour coded boots(backshells) and rings to assist in cable identification.
- In-line adaptors. Pre-wired for convenience.
- Termination tool for fast assembly of cable connectors.
- Mounting hardware.
- Metal boots(backshells) for rugged environments.



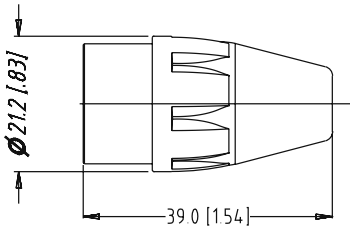
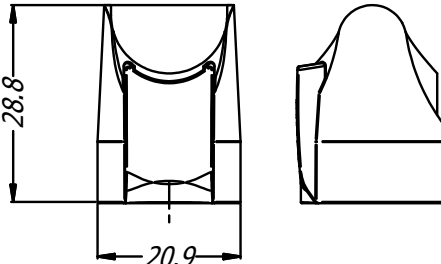

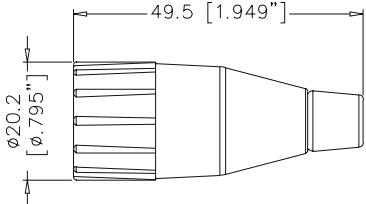

PRODUCT - FIGURE	DRAWING	DESCRIPTION	VARIATIONS	PART NUMBER
		XLR 3 pole male to 3 pole male adapter, Pre wired, Metal Shell	Nickel Finish	AC3M3MW
			Black Finish	AC3M3MBW
		XLR 3 pole female to 3 pole female adapter, Pre wired, Metal Shell	Nickel Finish	AC3F3FW
			Black Finish	AC3F3FBW
		XLR 3 pole female to 3 pole male adapter, Pre wired, Metal Shell	Nickel Finish	AC3F3MW
			Black Finish	AC3F3MBW
		XLR 3 pole female to 5 pole male adapter, Pre wired, Metal Shell	Nickel Finish	AC3F5MW
		XLR 3 pole male to 5 pole female adapter, Pre wired, Metal Shell	Nickel Finish	AC3M5FW
		XLR 5 pole male to 5 pole male adapter, Pre wired, Metal Shell	Nickel Finish	AC5M5MW
		XLR D shell adapter, 3 pole male to 3 pole male, Pre-wired	Not Applicable	AC3M3MDW
		XLR D shell adapter, 3 pole female to 3 pole female, Pre-wired	Not Applicable	AC3F3FDW

Accessories

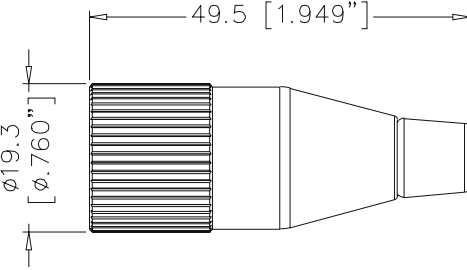
PRODUCT - FIGURE	DRAWING Dimensions in mm (inches)	DESCRIPTION	VARIATIONS	PART NUMBER
		AX Series Coloured Boot	Brown Red Orange Yellow Green Blue Violet Grey White Black	AX-BOOT-1 AX-BOOT-2 AX-BOOT-3 AX-BOOT-4 AX-BOOT-5 AX-BOOT-6 AX-BOOT-7 AX-BOOT-8 AX-BOOT-9 AX-BOOT
		AX Series Sleeve for Custom Print Note: Custom printed numbers available (Please contact us)	Black Brown Red Orange Yellow Green Blue Violet Grey White	AX-MARK0 AX-MARK1 AX-MARK2 AX-MARK3 AX-MARK4 AX-MARK5 AX-MARK6 AX-MARK7 AX-MARK8 AX-MARK9
		AC Coloured Boot / Backshell Note: Number Identification optional. (Please contact us.)	Brown Red Orange Yellow Green Blue Violet Grey White	AC-NUT-BRN AC-NUT-RED AC-NUT-ORG AC-NUT-YEL AC-NUT-GRN AC-NUT-BLU AC-NUT-VIO AC-NUT-GRY AC-NUT-WHT
		Coloured Grommets to suit AC Series, T Series and Musician range	Brown Red Orange Yellow Green Blue Violet Grey White	AC-GROMMET-BRN AC-GROMMET-RED AC-GROMMET-ORG AC-GROMMET-YEL AC-GROMMET-GRN AC-GROMMET-BLU AC-GROMMET-VIO AC-GROMMET-GRY AC-GROMMET-WHT

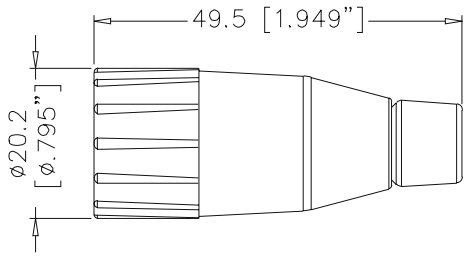
NOTE: All accessories comply with EU RoHS 2 Directive 2011/65/EU

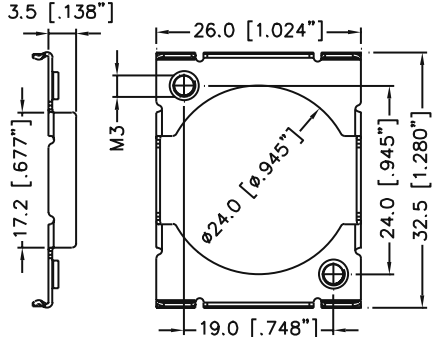
NOTE: Please do not refer to this printed catalogue as a colour reference. For exact colours contact your sales representative.

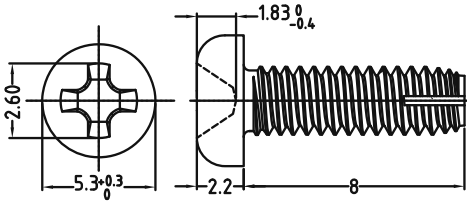
PRODUCT - FIGURE	DRAWING Dimensions in mm (inches)	DESCRIPTION	VARIATIONS	PART NUMBER
		AC Metal Boot / Backshell, Black Finish	Not Applicable	AC-NUT-METAL
		AC Thermoplastic Boot / Backshell. Suitable for use with 8.5mm (0.33") O.D. cable.	Not Applicable	AC-NUT-J-BLK
		M3 threaded metal plate to suit D-type chassis connectors	Nickel Finish	52590060-300
		M3 x 0.5mm thread Dual rear panel clip	Nickel Finish	52590074-300
		M3 Screw to suit 52590060-300 M3 x 0.5	Nickel Finish Matt Black	52500016-300 52500016-400

Connector Wiring Information

CONNECTOR WIRING INFORMATION

XLR (Microphone / Patch Cables)

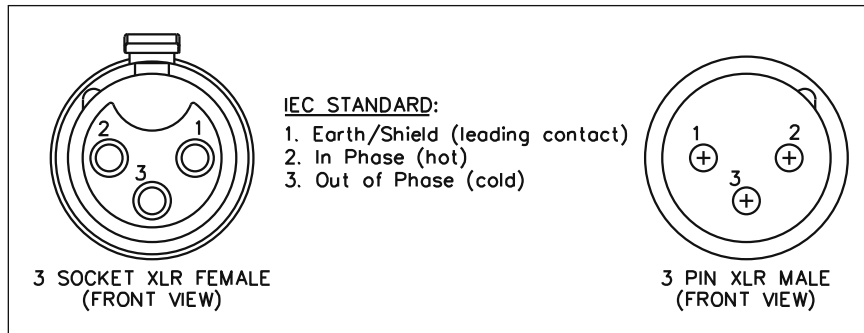

The standard XLR 3 contact pin outs are as shown above for a balanced lead. In such a configuration audio "Hot" (pin 2) is the in-phase connection whilst audio "Cold" (pin 3) is the out-of-phase connection. For an unbalanced lead however, you may connect pin 1 to either pin 2 or pin 3, but not both. In such a configuration the remaining pin is used for the audio signal.

When terminating the cable shielding to pin 1 it is suggested that the shield be only grounded at one end of the cable to avoid inducing "hum". Pin 1 is a leading contact that engages at interconnection, before pin 2 or pin 3.

1/4" Phono (6.35mm) (Standard Applications)

MICROPHONE CABLE - BALANCED

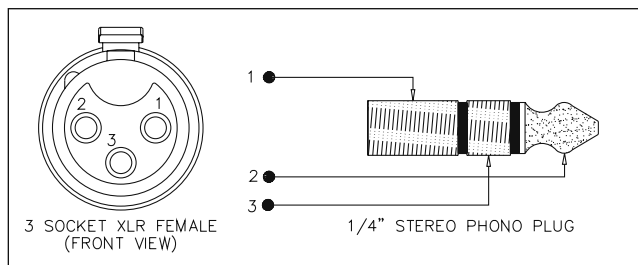

MICROPHONE CABLE - UNBALANCED

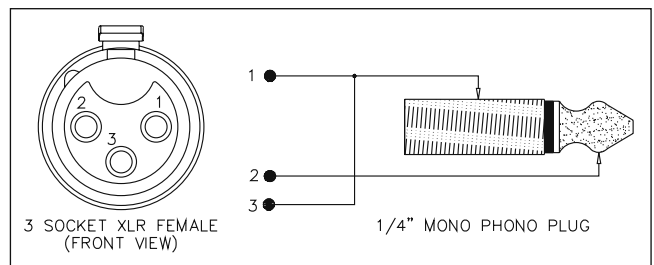

INSTRUMENT / LINE CABLE (MONO)

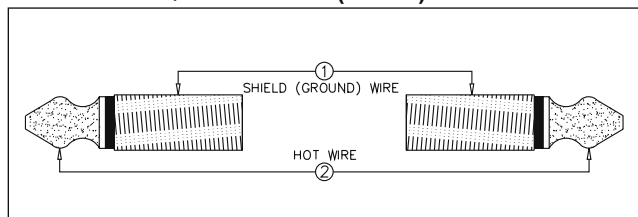

INSTRUMENT / LINE CABLE (STEREO)

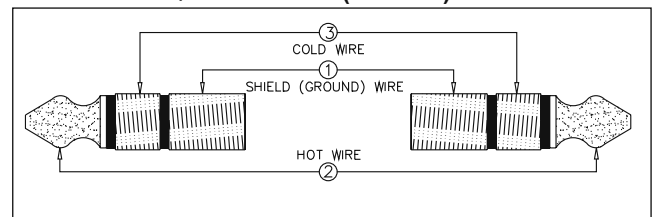

MP Series

MP-41 Series
4 Ch – 13 pin

Ch	+	-	G
1	B	C	E
2	F	K	H
3	J	D	A
4	N	M	G
General	L		
Ground			

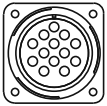

MP-41 Series
6 Ch – 19 pin

Ch	+	-	G
1	L	M	U
2	A	N	B
3	K	J	T
4	V	P	C
5	H	S	G
6	R	D	E
General	F		
Ground			

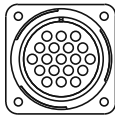

MP-41 Series
8 Ch – 25 pin

Ch	+	-	G
1	A	E	F
2	G	C	B
3	D	H	J
4	M	L	K
5	Q	P	N
6	W	S	R
7	T	X	Y
8	Z	V	U
General	a		
Ground			

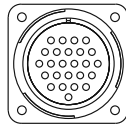

MP-41 Series
12 Ch – 37 pin

Ch	+	-	G
1	E	F	A
2	B	C	G
3	H	J	D
4	S	T	K
5	L	M	U
6	V	W	N
7	P	R	X
8	a	b	g
9	c	d	j
10	e	f	m
11	n	p	h
12	r	s	k
General	z		
Ground			

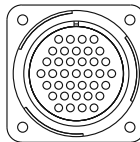

MP-41 Series
16 Ch – 54 pin

Ch	+	-	G
1	W	f	r
2	J	R	a
3	k	v	AC
4	E	M	V
5	e	q	y
6	B	H	P
7	Z	j	u
8	D	L	U
9	d	p	x
10	A	G	O
11	Y	h	t
12	C	K	T
13	c	n	w
14	F	N	X
15	g	s	AB
16	S	b	m
General	AG		
Ground			

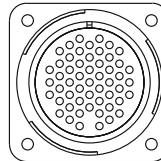

MP-41 Series
28 Ch – 85 pin

Ch	+	-	G
1	A	B	C
2	E	F	H
3	J	K	L
4	N	P	R
5	S	T	U
6	X	Y	Z
7	a	b	c
8	d	f	g
9	h	i	j
10	k	m	n
11	p	q	r
12	t	u	v
13	w	x	y
14	z	AA	AB
15	AC	AD	AE
16	AF	AH	AJ
17	AK	AL	AM
18	AP	AR	AS
19	AT	AU	AV
20	AW	AX	AY
21	AZ	BA	BB
22	BC	BD	BE
23	BJ	BK	BL
24	BM	BN	BP
25	BS	BT	BU
26	BV	BR	BF
27	BH	AN	s
28	W	M	D
General	V		
Ground			

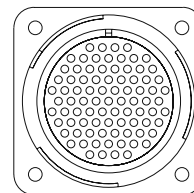

MP-41 Series
48 Ch - 150 pin

Ch	+	-	G
1	1	2	3
2	5	6	7
3	8	9	10
4	11	12	13
5	14	15	16
6	17	18	19
7	21	22	23
8	24	25	26
9	27	28	29
10	20	30	31
11	32	33	34
12	35	36	37
13	38	39	40
14	41	42	43
15	44	45	46
16	47	48	49
17	50	51	52
18	53	54	55
19	57	58	59
20	60	61	62
21	63	64	65
22	66	67	68
23	69	70	71
24	72	73	74
25	75	76	77
26	78	79	80
27	82	83	84
28	85	86	87
29	88	89	90
30	91	92	93
31	94	95	96
32	97	98	99
33	100	101	102
34	103	104	105
35	56	81	106
36	107	108	109
37	110	111	112
38	113	114	115
39	116	117	118
40	119	120	121
41	122	123	124
42	125	126	127
43	139	128	129
44	130	131	132
45	133	134	135
46	136	137	138
47	140	141	142
48	143	144	145
General			
Ground	150		

MP-62 Series
12 Ch – 39 pin

Ch	+	-	G
1	p	n	q
2	W	A	X
3	N	f	P
4	L	e	M
5	J	d	K
6	G	c	H
7	E	b	F
8	D	a	Z
9	C	B	Y
10	U	j	V
11	i	h	T
12	R	g	S
General	N/A		
Ground			



MP-62 Series
20 Ch – 61 pin

Ch	+	-	G
1	JJ	HH	NN
2	MM	KK	PP
3	BB	AA	CC
4	s	FF	W
5	r	EE	V
6	e	D	x
7	f	E	y
8	q	DD	U
9	S	p	T
10	P	N	R
11	m	k	n
12	L	K	M
13	J	i	j
14	H	G	h
15	g	F	z
16	d	C	w
17	B	A	c
18	b	a	Z
19	v	u	Y
20	t	GG	X
General	N/A		
Ground			

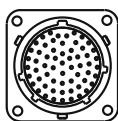

INDEX

Symbols

52500005-732	135
52500014-734	135
52500016-300	137
52500016-400	137
52590060-300	137
52590074-300	137

A

AC3F	10
AC3F3FBW	134
AC3F3FDW	134
AC3F3FW	134
AC3F3MBW	134
AC3F5MW	134
AC3FAH1-AU-PRE	30
AC3FAH2-AU-PRE	30
AC3FAH-AU-PRE	30
AC3FAHL1-AU-PRE	30
AC3FAHL2-AU-PRE	30
AC3FAHL-AU-PRE	30
AC3FAV1-AU-PRE	30
AC3FAV2-AU-PRE	31
AC3FAV-AU-PRE	30
AC3FAVL1-AU-PRE	31
AC3FAVL2-AU-PRE	31
AC3FAVL-AU-PRE	31
AC3FB	10
AC3FB-AU	10
AC3FB BULK	10
AC3FBH1-AU-PRE	33
AC3FBH2-AU-PRE	33
AC3FBH3-AU-PRE	33
AC3FBH-AU-PRE	33
AC3FBHL1-AU-PRE	34
AC3FBHL2-AU-PRE	34
AC3FBHL3-AU-PRE	34
AC3FBHL-AU-PRE	33
AC3FBJ	10
AC3F BULK	10
AC3FBV1-AU-PRE	34
AC3FBV2-AU-PRE	34
AC3FBV3-AU-PRE	34
AC3FBV-AU-PRE	34
AC3FBVL1-AU-PRE	35
AC3FBVL2-AU-PRE	35
AC3FBVL3-AU-PRE	35
AC3FBVL-AU-PRE	34
AC3FCP	14
AC3FCP BULK	14
AC3FDZ	21
AC3FDZB	21
AC3FDZB-AU	21
AC3FDZ BULK	21
AC3FJ	10
AC3FPZ	24
AC3M	10
AC3M3MBW	134
AC3M3MDW	134
AC3M3MW	134
AC3M5FW	134
AC3MA-AU-PRE	30
AC3MAH1-AU-PRE	29
AC3MAH2-AU-PRE	29
AC3MAH4-SW-B	29
AC3MAH-AU-PRE	29
AC3MAV2-AU-PRE	30
AC3MAV-AU-PRE	29
AC3MB	10
AC3MB-AU	10
AC3MB BULK	10
AC3MBH1-AU-PRE	32
AC3MBH2-AU-PRE	32
AC3MBH3-AU-PRE	32
AC3MBH-AU-PRE	32

AC3MBHL-AU-PRE	32
AC3MBJ	10
AC3M BULK	10
AC3MBV1-AU-PRE	33
AC3MBV2-AU-PRE	33
AC3MBV3-AU-PRE	33
AC3MBV-AU-PRE	32
AC3MCP	14
AC3MCP BULK	14
AC3MDZ	21
AC3MDZB	21
AC3MDZB-AU	21
AC3MDZ BULK	21
AC3MJ	10
AC3MM	10
AC3MMB	10
AC3MMB-AU	10
AC3MMB BULK	10
AC3MM BULK	10
AC3MMCP	14
AC3MMCP BULK	14
AC3MMDZ	21
AC3MMDZB	21
AC3MMDZB-AU	21
AC3MMDZ BULK	21
AC3MMP	24
AC3MMPNZ	24
AC3MP	24
AC3MPNZ	24
AC4F	11
AC4FB	11
AC4FB-AU	11
AC4FB BULK	11
AC4FBJ	11
AC4F BULK	11
AC4FDZ	22
AC4FDZB	22
AC4FDZB-AU	22
AC4FDZ BULK	22
AC4FJ	11
AC4FPZ	24
AC4M	11
AC4MAH-AU-B	31
AC4MB	11
AC4MB-AU	11
AC4MB BULK	11
AC4MBJ	11
AC4M BULK	11
AC4MDZ	22
AC4MDZB	22
AC4MDZB-AU	22
AC4MJ	11
AC4MP	24
AC4MPNZ	24
AC5F	11
AC5F5FDW	135
AC5FAH-AU-B	31
AC5FAV-AU-B	31
AC5FB	11
AC5FB-AU	11
AC5FB BULK	11
AC5FBH-AU-PRE	35
AC5FBJ	11
AC5F BULK	11
AC5FBV-AU-PRE	35
AC5FDZ	22
AC5FDZB	22
AC5FDZB-AU	22
AC5FDZ BULK	22
AC5FJ	11
AC5FPZ	24
AC5M	11
AC5M5MDW	135
AC5M5MW	134
AC5MAH-AU-B	31
AC5MAV-AU-B	31
AC5MB	11

AC5MB-AU	11
AC5MB BULK	11
AC5MBH-AU-PRE	35
AC5MBJ	11
AC5M BULK	11
AC5MBV-AU-PRE	35
AC5MDZ	22
AC5MDZB	22
AC5MDZB-AU	22
AC5MDZ BULK	22
AC5MJ	11
AC5MP	24
AC5MPNZ	24
AC6AF	12
AC6AFB	12
AC6AFB-AU	12
AC6AFB BULK	12
AC6AFBJ	12
AC6AF BULK	12
AC6AFDZ	23
AC6AFDZB	23
AC6AFDZB-AU	23
AC6AFDZ BULK	23
AC6AFJ	12
AC6AFPZ	24
AC6AM	12
AC6AMB	12
AC6AMB-AU	12
AC6AMB BULK	12
AC6AMBJ	12
AC6AM BULK	12
AC6AMDZ	23
AC6AMDZB	23
AC6AMDZB-AU	23
AC6AMDZ BULK	23
AC6AMJ	12
AC6AMP	24
AC6AMPNZ	24
AC7F	12
AC7FB	12
AC7FB BULK	12
AC7FBJ	12
AC7F BULK	12
AC7FDZ	23
AC7FDZB	23
AC7FDZ BULK	23
AC7FDZV	23
AC7FDZVB	23
AC7FJ	12
AC7FPZ	24
AC7M	12
AC7MB	12
AC7MB BULK	12
AC7MBJ	12
AC7M BULK	12
AC7MDZ	23
AC7MDZB	23
AC7MDZ BULK	23
AC7MDZV	23
AC7MDZVB	23
AC7MJ	12
AC7MP	24
AC7MPNZ	24
AC-D-ADAPTER	135
AC-GROMMET-BRN	136
AC-GROMMET-GRN	136
AC-GROMMET-GRY	136
AC-GROMMET-ORG	136
AC-GROMMET-RED	136
AC-GROMMET-VIO	136
AC-GROMMET-WHT	136
AC-GROMMET-YEL	136
AC-HDMI-RR	90
AC-HDMI-RRB	90
ACJC5H BULK	45
ACJC5HL BULK	45
ACJC5S BULK	45

ACJC5SL BULK	45
ACJC5V BULK	45
ACJC5VL BULK	45
ACJC6AH BULK	43
ACJC6AHL BULK	43
ACJC6AV2 BULK	43
ACJC6AV2L BULK	43
ACJC6AV BULK	43
ACJC6AVL BULK	43
ACJC6H BULK	46
ACJC6HL BULK	46
ACJC6S BULK	46
ACJC6SL BULK	46
ACJC6V BULK	46
ACJC6VL BULK	46
ACJC9AH BULK	43
ACJC9AHL BULK	43
ACJC9AV2 BULK	44
ACJC9AV2L BULK	44
ACJC9AVL BULK	44
ACJC9H BULK	46
ACJC9S BULK	47
ACJC9SL BULK	47
ACJC9V BULK	47
ACJC9VL BULK	47
ACJC10AH BULK	44
ACJC10AHL BULK	44
ACJC10AV2 BULK	44
ACJC10AV2L BULK	44
ACJC10AV BULK	44
ACJC10AVL BULK	44
ACJC10H BULK	47
ACJC10HL BULK	47
ACJC10S BULK	48
ACJC10SL BULK	48
ACJC10V BULK	47
ACJC10VL BULK	47
ACJD-BLK	123
ACJD-BLU	123
ACJD-GRN	123
ACJD-RED	123
ACJD-WHT	123
ACJD-YEL	123
ACJM-HHDR	109
ACJM-HHOP	110
ACJM-HHOP-1	110
ACJM-IH	111
ACJM-IHS	111
ACJM-MC	111
ACJM - MH	110
ACJM-MHD	112
ACJM-MHD985	109
ACJM-MHDC*	111
ACJM-MHDCM	111
ACJM-MHDE	112
ACJM-MHDEM	112
ACJM-MHDM	112
ACJM-MHDR	110
ACJM-MHDRM	110
ACJM-MHOM	110
ACJM-MHOP	110
ACJM-MHOP-1	110
ACJM-MHR	111
ACJM-MHS	111
ACJM-MIV-2	112
ACJM-MIV-2S	112
ACJM-MN-2	112
ACJM-MN-2S	112
ACJM-MV-2	112
ACJM-MV-2S	112
ACJM-MV35-2	109
ACJM-MV35-2S	109
ACJM-MVD985-2	109
ACJM-MVD985-2S	109
ACJM-MVS-2	113
ACJM-MVS-2S	113

ACJM-NH35	109
ACJM-NV35-2	109
ACJM-NV35-2S	109
ACJM-PC	111
ACJM - PH	110
ACJM-PHOP	110
ACJM-PHOP-1	110
ACJM-PHR	111
ACJM-PHS	111
ACJM-PVB-2	112
ACJM-PVB-2S	112
ACJR-BLK	122
ACJR-BLU	122
ACJR-GRN	122
ACJR-RED	122
ACJR-SBK	122
ACJR-SBL	122
ACJR-SGR	122
ACJR-SRD	122
ACJR-SWH	122
ACJR-SYL	122
ACJR-WHT	122
ACJR-YEL	122
ACJS-HHDR	109
ACJS-HHOP	110
ACJS-HHOP-1	110
ACJS-IH	111
ACJS-IHS	111
ACJS-MC	111
ACJS - MH	111
ACJS-MHD	112
ACJS-MHD985	109
ACJS-MHDC*	111
ACJS-MHDCM	111
ACJS-MHDE	112
ACJS-MHDEM	112
ACJS-MHDM	112
ACJS-MHDR	110
ACJS-MHDRM	110
ACJS-MHOM	110
ACJS-MHOP	110
ACJS-MHOP-1	110
ACJS-MHR	111
ACJS-MHS	111
ACJS-MIV-3	112
ACJS-MIV-3S	112
ACJS-MIV-5	112
ACJS-MN-3	112
ACJS-MN-3S	112
ACJS-MN-5	112
ACJS-MV-3	112
ACJS-MV-3S	112
ACJS-MV35-3	109
ACJS-MV35-3S	109
ACJS-MV35-5	109
ACJS-MVD985-3	109
ACJS-MVD985-3S	109
ACJS-MVD985-5	109
ACJS-MVS-3	113
ACJS-MVS-3S	113
ACJS-MVS-5	113
ACJS-NH35	109
ACJS-NV35-3	109
ACJS-NV35-3S	109
ACJS-NV35-5	109
ACJS-PC	111
ACJS - PH	111
ACJS-PHOP	110
ACJS-PHOP-1	110
ACJS-PHR	111
ACJS-PHS	111
ACJS-PVB-3	112
ACJS-PVB-3S	112
ACJS-PVB-5	112
AC-NUT-BLU	136
AC-NUT-BRN	136

AC-NUT-GRN	136	AG4F	51	AX4M BULK	4				
AC-NUT-GRY	136	AG4FCCH	51	AX4MD	18	EP-4-14	66	M	
AC-NUT-J-BLK	137	AG4FCE	51	AX4MDB	18	EP-4-14B	66	M22520/1-01	129
AC-NUT-METAL	137	AG4FCRV	52	AX4MDB-AU	18	EP-5-11P	65	MP-738-39L	132
AC-NUT-ORG	136	AG4FL	51	AX4MD-M3	18	EP-5-11PB	65	MP-738-39S	132
AC-NUT-RED	136	AG4M	51	AX4MDV	18	EP-5-12	65	MP-738-61L	132
AC-NUT-VIO	136	AG4MCC	51	AX4MDVB	18	EP-5-12B	65	MP-738-61S	132
AC-NUT-WHT	136	AG4MCCH	51	AX4MDV-M3	18	EP-5-13P	66	MP-742-39L	132
AC-NUT-YEL	136	AG4MPCH	52	AX5F	4	EP-5-13PB	66	MP-742-39S	132
ACPL-CBK	122	AG5F	51	AX5FB	4	EP-5-14	66	MP-742-61L	132
ACPL-CBL	122	AG5FCCH	51	AX5FB-AU	4	EP-5-14B	66	MP-742-61S	132
ACPL-CGR	122	AG5FCE	51	AX5FB BULK	4	EP-6-11P	65	MP-4101-13P	126
ACPL-CRD	122	AG5FCRV	52	AX5F BULK	4	EP-6-11PB	65	MP-4101-13P-C	126
ACPL-CWH	122	AG5FL	51	AX5FD	19	EP-6-12	65	MP-4101-19P	126
ACPL-CYL	122	AG5M	51	AX5FD-M3	19	EP-6-12B	65	MP-4101-19P-C	126
ACPM-GB	105	AG5MCC	51	AX5FDV	19	EP-6-13P	66	MP-4101-25P	126
ACPM-GB-AU	105	AG5MCCH	51	AX5FDV-M3	19	EP-6-13PB	66	MP-4101-25P-C	126
ACPM-GB BULK	105	AG6F	51	AX5M	4	EP-6-14	66	MP-4101-37P	126
ACPM-GN	105	AG6FCCH	51	AX5MB	4	EP-6-14B	66	MP-4101-37P-C	126
ACPM-GN-AU	105	AG6FCE	51	AX5MB-AU	4	EP-8-11P	65	MP-4101-54P	126
ACPM-GN BULK	105	AG6FCRV	52	AX5MB BULK	4	EP-8-11PB	65	MP-4101-54P-C	126
ACPM-KB	103	AG6FL	51	AX5M BULK	4	EP-8-12	65	MP-4101-85P	126
ACPM-KB-AU	103	AG6M	51	AX5MD	18	EP-8-12B	65	MP-4101-85P-C	126
ACPM-KN	103	AG6MCC	51	AX5MDB	18	EP-8-13P	66	MP-4101-150P	126
ACPM-KN-AU	103	AG6MCCH	51	AX5MDB-AU	18	EP-8-13PB	66	MP-4101-150P-C	126
ACPM-RB	106	AP-4-11	67	AX5MD-M3	18	EP-8-14	66	MP-4102-13P	127
ACPM-RB-AU	106	AP-4-12	67	AX5MDV	18	EP-8-14B	66	MP-4102-13P-C	127
ACPM-RB BULK	106	AP-4-21	67	AX5MDVB	18			MP-4102-19P	127
ACPM-RN	106	AP-4-22	67	AX5MDV-M3	18	H		MP-4102-19P-C	127
ACPM-RN-AU	106	AP-5-11	67	AX6AFD	19	HP-3-F	70	MP-4102-25P	127
ACPM-RN BULK	106	AP-5-12	67	AX6AFDB	19	HP-3-FG	70	MP-4102-25P-C	127
ACPM-TB	104	AP-5-21	67	AX6AFD-M3	19	HP-3-MD	70	MP-4102-37P	127
ACPM-TB-AU	104	AP-5-22	67	AX6AFDV	19	HP-3-MDG	70	MP-4102-37P-C	127
ACPM-TB BULK	104	AP-6-11	67	AX6AFDV-B	19	HP-3-MDGW	70	MP-4102-54P	127
ACPM-TN	104	AP-6-12	67	AX6AFDV-M3	19	HP-3-MDW	70	MP-4102-54P-C	127
ACPM-TN-AU	104	AP-6-21	67	AX6AMD	19	HPT-3-CC	72	MP-4102-85P	127
ACPM-TN BULK	104	AP-6-22	67	AX6AMDB	19	HPT-3-CC	72	MP-4102-85P-C	127
ACPR-BLK	122	AP-8-11	67	AX6AMDB-AU	19	HPT-3-F	72	MP-4102-150P	127
ACPR-BLU	122	AP-8-12	67	AX6AMD-M3	19	HPT-3-FD	72	MP-4102-150P-C	127
ACPR-GRN	122	AP-8-21	67	AX6AMDV	19	HPT-3-FDW	72	MP-4106-13S	126
ACPR-RED	122	AP-8-22	67	AX6AMDVB	19	HPT-3-FJ	72	MP-4106-13S-C	126
ACPR-SBK	122	AX3F	3	AX6AMDV-M3	19	HPT-3-M	72	MP-4106-19S	126
ACPR-SBL	122	AX3FB	3	AX6FADB-AU	19	HPT-3-MD	72	MP-4106-19S-C	126
ACPR-SGR	122	AX3FB-AU	3	AX-BOOT	136	HPT-3-MDW	72	MP-4106-25S	126
ACPR-SRD	122	AX3FB BULK	3	AX-BOOT-1	136	HPT-3-MJ	72	MP-4106-25S-C	126
ACPR-SWH	122	AX3F BULK	3	AX-BOOT-2	136	HPT-CAPD	73	MP-4106-37S	126
ACPR-SYL	122	AX3FD	17	AX-BOOT-3	136	HPT-CAPF	73	MP-4106-37S-C	126
ACPR-WHT	122	AX3FDB	17	AX-BOOT-4	136	HPT-CAPM	73	MP-4106-54S	126
ACPR-YEL	122	AX3FDB-AU	17	AX-BOOT-5	136	HPT-CAPSD	73	MP-4106-54S-C	126
ACPS-GB	105	AX3FDB-M3	17	AX-BOOT-6	136	HPT-CAPSF	73	MP-4106-85S	126
ACPS-GB-AU	105	AX3FD-M3	17	AX-BOOT-7	136	HPT-CAPSM	73	MP-4106-85S-C	126
ACPS-GB BULK	105	AX3M	3	AX-BOOT-8	136	HPT-RT	73	MP-4106-150S	126
ACPS-GN	105	AX3MB	3	AX-BOOT-9	136			MP-4106-150S-C	126
ACPS-GN-AU	105	AX3MB-AU	3	AX-MARK0	136	J		MP-4164-13S	127
ACPS-GN BULK	105	AX3MB BULK	3	AX-MARK1	136	JM2P	96	MP-4164-13S-C	127
ACPS-KB	103	AX3M BULK	3	AX-MARK2	136	JM2P-AU	96	MP-4164-19S	127
ACPS-KB-AU	103	AX3MD	17	AX-MARK3	136	JM2PB	96	MP-4164-19S-C	127
ACPS-KN	103	AX3MDB	17	AX-MARK4	136	JM2PB-AU	96	MP-4164-25S	127
ACPS-KN-AU	103	AX3MDB-AU	17	AX-MARK5	136	JM2PB BULK	96	MP-4164-25S-C	127
ACPS-RB	106	AX3MDB-M3	17	AX-MARK6	136	JS3P	96	MP-4164-37S	127
ACPS-RB-AU	106	AX3MD-M3	17	AX-MARK7	136	JS3P-AU	96	MP-4164-37S-C	127
ACPS-RB BULK	106	AX3MDV	17	AX-MARK8	136	JS3PB	96	MP-4164-54S	127
ACPS-RN	106	AX3MDVB	17	AX-MARK9	136	JS3PB-AU	96	MP-4164-54S-C	127
ACPS-RN-AU	106	AX3MDVB-M3	17	AXX3F	3, 4			MP-4164-85S	127
ACPS-RN BULK	106	AX3MDV-M3	17			K		MP-4164-85S-C	127
ACPS-TB	104	AX4F	4	E		KM2P	118	MP-4164-150S	127
ACPS-TB-AU	104	AX4FB	4	EP-3-11P	65	KM2P-AU	118	MP-4164-150S-C	127
ACPS-TB BULK	104	AX4FB-AU	4	EP-3-11PB	65	KM2PB	118	MP-6211-39S	131
ACPS-TN	104	AX4FB BULK	4	EP-3-12	65	KM2PB-AU	118	MP-6211-39S-C	131
ACPS-TN-AU	104	AX4F BULK	4	EP-3-12B	65	KM2PB BULK	118	MP-6211-61S	131
ACPS-TN BULK	104	AX4FD	18	EP-3-13P	66	KM2P BULK	118	MP-6211-61S-C	131
AC-USB3-AA	90	AX4FDB	18, 19	EP-3-13PB	66	KS3P	118	MP-6212-39S	132
AC-USB3-AAB	90	AX4FDB-AU	18, 19	EP-3-14	66	KS3P-AU	118	MP-6212-39S-C	132
AG3F	51	AX4FD-M3	18	EP-3-14B	66	KS3PB	118	MP-6212-61S	132
AG3FCCH	51	AX4FDV	18	EP-4-11P	65	KS3PB-AU	118	MP-6212-61S-C	132
AG3FCE	51	AX4FDVB	18, 19	EP-4-11PB	65	KS3PB BULK	118	MP-6216-39P	131
AG3FCRV	52	AX4FDV-M3	18	EP-4-12	65	KS3PB BULK	118	MP-6216-39P-C	131
AG3FL	51	AX4M	4	EP-4-12B	65	KS3P BULK	118	MP-6216-61P	131
AG3M	51	AX4MB	4	EP-4-12B	65	KS3PC	118	MP-6216-61P-C	131
AG3MCC	51	AX4MB-AU	4	EP-4-13P	66	KS3PC-AU	118	MP-6256-39P	132
AG3MCCH	51	AX4MB BULK	4	EP-4-13PB	66			MP-6256-39P-C	132

PRODUCT SAFETY INFORMATION

This should be read in conjunction with Data Sheet information contained in individual product brochures. Failure to observe the advice in this information sheet and the operating conditions specified in the Data Sheets could result in hazardous situations.

1. Material Content and Physical Form

Electrical connectors do not usually contain hazardous materials. They contain conducting and non-conducting materials. Shells are manufactured in metal and plastic. Insulators can be formed in either natural rubber, synthetic rubber, plastic or glass insulating materials. Contact materials vary with the type of connector and its application. They are usually manufactured from either copper alloys, nickel, alumel, chromel or steel. In special applications, other alloys may be specified.

2. Fire Characteristics and Electric Shock Hazard

There is no fire hazard when the connector is correctly wired and used within the specified parameters. Incorrect wiring or assembly of the connector or careless use of metal tools or conductive fluids, or transit damage to any of the component parts may cause electric shock or burns. Live circuits must not be broken by separating mated connectors as this may cause arcing, ionisation and burning. Heat dissipation is greater at maximum resistance in a circuit. Hot spots may occur when resistance is raised locally by damage, e.g. cracked or deformed contacts, or broken strands of wire. Local overheating may also result from the use of the incorrect application tools or from poor quality soldering.

Overheating may occur if the ratings in the Data Sheets are exceeded and can cause breakdown of insulation and hence electric shock.

If heating is allowed to continue it intensifies by further increasing the local resistance through loss of temper or spring contact, formation of oxide film on contacts and wires, and leakage currents through carbonisation of insulation and tracking points. Fire can then result in the presence of combustible materials and this may release noxious fumes. Overheating may not be visually apparent. Burns may result from touching overheated components.

3. Handling

Care must be taken to avoid damage to any component parts of electrical connectors during installation and use. Although there are normally no sharp edges, care must be taken when handling certain components to avoid injury to fingers. Electrical connectors may be damaged in transit to customers, and damage may result in creation of hazards. Products should therefore be examined prior to installation/use and rejected if found to be damaged.

4. Disposal

Incineration of certain materials may release noxious or even toxic fumes.

5. Application

Connectors with exposed contacts should not be selected for use on the current supply side of an electrical circuit, because an electric shock could result from touching exposed contacts of an unmated connector. Voltages in excess of 30 V.A.C. or 42.5 V.D.C. are potentially hazardous and care should be taken to ensure that such voltages cannot be transmitted in any way to exposed metal parts of the connector body. The connector and wiring should be checked, before making live, to have no damage to metal parts or insulators, no solder blobs, loose strands, conducting lubricants, swarf, or any other undesired conducting particles.

Circuit resistance and continuity check should be made to make certain that there are no low resistance joints or spurious conducting paths. Always use the correct application tools as specified in the Data Sheets. Do not permit untrained personnel to wire, assemble or tamper with connectors. For operation voltage please see appropriate national regulations.

Important General Information

A) Air and creepage paths / Operating voltage.

The admissible operating voltages depend on the individual applications and the valid national and other applicable safety regulations. For this reason the air and creepage path data are only reference values. Observe reduction of air and creepage paths due to PC board and/or harnessing.

B) Other important information

Amphenol Australia Pty Ltd continuously endeavours to improve its products. Therefore, products may deviate from the description, technical data and shape as shown in product brochures.

C) Assembly instructions

If applicable, special assembly instructions have been included in or on the connector packaging. See also separate instructions in product brochures.

DISTRIBUTED BY

International Headquarters

Amphenol Australia Pty Ltd
22 Industry Blvd.
Carrum Downs VIC 3201 Australia
Phone: +61 3 8796 8888
Email: info@amphenol.com.au

Europe

Amphenol Audio Representative Office
August-Haesser – Str. 10
74080 Heilbronn Germany
Phone: +49 71 31 9 29 0
Email: industrial@amphenol.de

www.amphenolaudio.com.au

© 2021 Amphenol Australia Pty Ltd

Subject to all applicable laws and regulations Amphenol Australia Pty Ltd reserves the right to change specifications of any product, system or service contained in this brochure without liability.
230922

Catalogue Part Number: CAT-AUDIO-01

North America

Amphenol Audio Representative Office
44724 Morley Drive
Clinton Township, MI, USA 48036
Phone: +1 800 394 7732 or +1 586 913 8650
Email: sales@amphenolaudio.com

Asia Pacific

Amphenol Australia (China Operations)
3rd floor, Building 9 Shan Cheng Industrial Zone,
Zhou Shi Road, Shi Yan Street, Bao An District,
Shen Zhen, China 518108
Phone: (+86) 755 8173 8000
Email: apcd@amphenol.com.au